



# THREADING GEWINDEDREHEN



Code system (ISO) Kodifizierung (ISO)	<b>C02</b>
Threading inserts Wendeschneidplatten zum Gewindedrehen	<b>C03-10</b>
Applications index Anwendungen	<b>C11</b>
External threading Außengewindedrehen	<b>C12-16</b>
Internal threading Innengewindedrehen	<b>C17-20</b>
Cutting data Schnittdaten	<b>C21-24</b>
Technical information Technische Auskünfte	<b>C25-26</b>

## Code system / Kodifizierung (ISO)

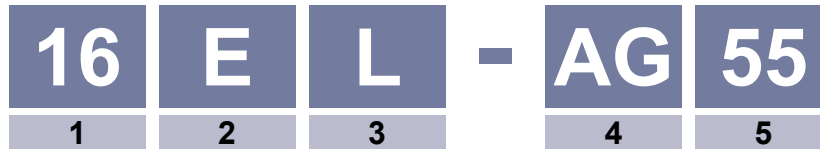

### 1 Insert size Wendeplattengröße

	IC=inch / Zoll	D=mm.
<b>06</b>	5/32	3,96
<b>08</b>	3/16	4,76
<b>11</b>	1/4	6,35
<b>16</b>	3/8	9,52
<b>22</b>	1/2	12,70
<b>27</b>	5/8	15,87

### 2 Insert type Wendeplattentyp

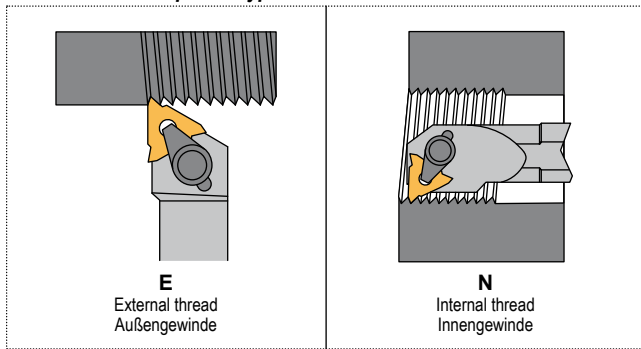

### 3 Hand of insert Wendeplattenausführung

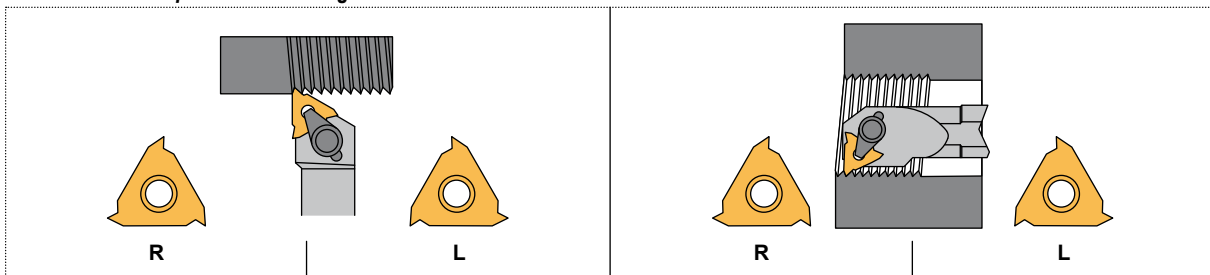

### 4 Pitch Steigung

p-mm. x 100  
p-inch / Zoll x 10

	mm.	TPI
<b>A</b>	0,5-1,5	48-16
<b>AG</b>	0,5-3,0	48-8
<b>G</b>	1,75-3,0	14-8
<b>N</b>	3,5-5,0	7-5
<b>S</b>	5,5-8,0	4½ - 3½

### 5 Standard Standard

<b>55</b>	Partial profile 55° / Teilprofil 55°
<b>60</b>	Partial profile 60° / Teilprofil 60°
<b>ISO</b>	ISO metric / ISO metrisch
<b>W</b>	Whitworth, BSW / Whitworth, BSW
<b>LG</b>	Groove type LG / Nutentyp LG

## Grade characteristics / Sorteneigenschaften

Grades Sorten	General use / Allgemeine Verwendung
<b>TL20</b>	General purpose grade with tough submicron substrate. Provides good fracture toughness in non-rigid cutting conditions. TiAlN coated. Universal-Beschichtung mit zähem Feinstkornsubstrat. Bietet gute Bruchfestigkeit bei unterschiedlichen Schnittbedingungen. TiAlN-beschichtet.
<b>TIN25</b>	General purpose grade, excellent in steel and stainless steel, recommended for rigid cutting conditions. Ground or sintered chipbreaker styles. TiN coated. Universal-Beschichtung hervorragend bei Stahl und rostfreiem Stahl, besonders bei unterschiedlichen Schnittbedingungen empfohlen. TiN-beschichtet.



ER



ER TD

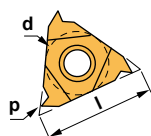

ER

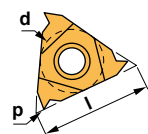

EL

### ER-60°

Partial profile thread forms - External inserts 60°-55° (non topping)  
Wendeschneidplatten (Teilprofil) 60°/55° zum Außengewindedrehen

Reference / Bezeichnung	l	d	p	TIN25	TL20
11ER-A60	11,00	6,35	60°	○	○
16ER-A60	16,00	9,52	60°	○	○
16ER-AG60	16,00	9,52	60°	●	○
16ER-G60	16,00	9,52	60°	●	○
22ER-N60	22,00	12,70	60°	●	○
27ER-S60	27,00	15,87	60°	○	○

### EL-60°

Partial profile thread forms - External inserts 60°-55° (non topping)  
Wendeschneidplatten (Teilprofil) 60°/55° zum Außengewindedrehen

Reference / Bezeichnung	l	d	p	TIN25	TL20
11EL-A60	11,00	6,35	60°	○	○
16EL-A60	16,00	9,52	60°	○	○
16EL-AG60	16,00	9,52	60°	○	○
16EL-G60	16,00	9,52	60°	○	○
22EL-N60	22,00	12,70	60°	○	○
27EL-S60	27,00	15,87	60°	○	○

### ER-55°

Partial profile thread forms - External inserts 60°-55° (non topping)  
Wendeschneidplatten (Teilprofil) 60°/55° zum Außengewindedrehen

Reference / Bezeichnung	l	d	p	TIN25	TL20
11ER-A55	11,00	6,35	55°	○	○
16ER-A55	16,00	9,52	55°	○	○
16ER-AG55	16,00	9,52	55°	●	○
16ER-G55	16,00	9,52	55°	○	○
22ER-N55	22,00	12,70	55°	○	○
27ER-S55	27,00	15,87	55°	○	○

### EL-55°

Partial profile thread forms - External inserts 60°-55° (non topping)  
Wendeschneidplatten (Teilprofil) 60°/55° zum Außengewindedrehen

Reference / Bezeichnung	l	d	p	TIN25	TL20
11EL-A55	11,00	6,35	55°	○	○
16EL-A55	16,00	9,52	55°	○	○
16EL-AG55	16,00	9,52	55°	○	○
16EL-G55	16,00	9,52	55°	○	○
22EL-N55	22,00	12,70	55°	○	○
27EL-S55	27,00	15,87	55°	○	○

### ER-60° TD

Partial profile thread forms - External inserts 60°-55° (non topping)  
Wendeschneidplatten (Teilprofil) 60°/55° zum Außengewindedrehen

Reference / Bezeichnung	l	d	p	TIN25	TL20
16ER-AG60 TD	16,00	9,52	60°	●	○

### ER-55° TD

Partial profile thread forms - External inserts 60°-55° (non topping)  
Wendeschneidplatten (Teilprofil) 60°/55° zum Außengewindedrehen

Reference / Bezeichnung	l	d	p	TIN25	TL20
16ER-AG55 TD	16,00	9,52	55°	●	○





NR

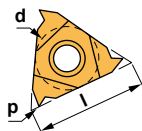

NR

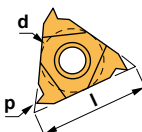

NL



NR-TD

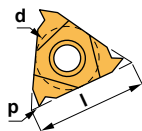

### NR-60°

Partial profile thread forms - Internal inserts 60°-55° (non topping)  
Wendeschneidplatten (Teilprofil) 60°/55° zum Innengewindedrehen

Reference / Bezeichnung	l	d	p	TIN25	TL20
06NR-A60	6,00	3,96	60°	○	○
08NR-A60	8,00	4,76	60°	○	○
11NR-A60	11,00	6,35	60°	●	○
16NR-A60	16,00	9,52	60°	○	○
16NR-AG60	16,00	9,52	60°	●	○
16NR-G60	16,00	9,52	60°	○	○
22NR-N60	22,00	12,70	60°	●	○
27NR-S60	27,00	15,87	60°	○	○

### NL-60°

Partial profile thread forms - Internal inserts 60°-55° (non topping)  
Wendeschneidplatten (Teilprofil) 60°/55° zum Innengewindedrehen

Reference / Bezeichnung	l	d	p	TIN25	TL20
06NL-A60	6,00	3,96	60°	○	○
08NL-A60	8,00	4,76	60°	○	○
11NL-A60	11,00	6,35	60°	○	○
16NL-A60	16,00	9,52	60°	○	○
16NL-AG60	16,00	9,52	60°	○	○
16NL-G60	16,00	9,52	60°	○	○
22NL-N60	22,00	12,70	60°	○	○
27NL-S60	27,00	15,87	60°	○	○

### NR-55°

Partial profile thread forms - Internal inserts 60°-55° (non topping)  
Wendeschneidplatten (Teilprofil) 60°/55° zum Innengewindedrehen

Reference / Bezeichnung	l	d	p	TIN25	TL20
06NR-A55	6,00	3,96	55°	○	○
08NR-A55	8,00	4,76	55°	○	○
11NR-A55	11,00	6,35	55°	○	○
16NR-A55	16,00	9,52	55°	○	○
16NR-AG55	16,00	9,52	55°	●	○
16NR-G55	16,00	9,52	55°	●	○
22NR-N55	22,00	12,70	55°	○	○
27NR-S55	27,00	15,87	55°	○	○

### NL-55°

Partial profile thread forms - Internal inserts 60°-55° (non topping)  
Wendeschneidplatten (Teilprofil) 60°/55° zum Innengewindedrehen

Reference / Bezeichnung	l	d	p	TIN25	TL20
06NL-A55	6,00	3,96	55°	○	○
08NL-A55	8,00	4,76	55°	○	○
11NL-A55	11,00	6,35	55°	○	○
16NL-A55	16,00	9,52	55°	○	○
16NL-AG55	16,00	9,52	55°	○	○
16NL-G55	16,00	9,52	55°	○	○
22NL-N55	22,00	12,70	55°	○	○
27NL-S55	27,00	15,87	55°	○	○

### NR-60° TD

Partial profile thread forms - Internal inserts 60°-55° (non topping)  
Wendeschneidplatten (Teilprofil) 60°/55° zum Innengewindedrehen

Reference / Bezeichnung	l	d	p	TIN25	TL20
16NR-AG60 TD	16,00	9,52	60°	●	○

### NR-55° TD

Partial profile thread forms - Internal inserts 60°-55° (non topping)  
Wendeschneidplatten (Teilprofil) 60°/55° zum Innengewindedrehen

Reference / Bezeichnung	l	d	p	TIN25	TL20
16NR-AG55 TD	16,00	9,52	55°	●	○



ER

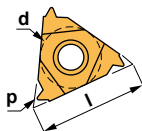

ER

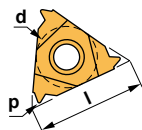

EL

## ER-ISO

Mechanical thread forms - External inserts **ISO (full form) BS36**  
Mechanische Gewindeformen / **ISO (Vollprofil) BS36** Wendeschneidplatten zum Außendrehen

Reference / Bezeichnung	l	d	p	TIN25	TL20
11ER-030ISO	11,00	6,35	0,30	○	○
11ER-040ISO	11,00	6,35	0,40	○	○
11ER-045ISO	11,00	6,35	0,45	○	○
11ER-050ISO	11,00	6,35	0,50	○	○
11ER-060ISO	11,00	6,35	0,60	○	○
11ER-070ISO	11,00	6,35	0,70	○	○
11ER-075ISO	11,00	6,35	0,75	○	○
11ER-080ISO	11,00	6,35	0,80	○	○
11ER-100ISO	11,00	6,35	1,00	○	○
11ER-125ISO	11,00	6,35	1,25	○	○
11ER-150ISO	11,00	6,35	1,50	○	○
11ER-175ISO	11,00	6,35	1,75	○	○
16ER-075ISO	16,00	9,52	0,75	○	○
16ER-100ISO	16,00	9,52	1,00	○	○
16ER-125ISO	16,00	9,52	1,25	○	○
16ER-150ISO	16,00	9,52	1,50	○	○
16ER-175ISO	16,00	9,52	1,75	○	○
16ER-200ISO	16,00	9,52	2,00	○	○
16ER-250ISO	16,00	9,52	2,50	○	○
16ER-300ISO	16,00	9,52	3,00	○	○
22ER-350ISO	22,00	12,70	3,50	○	○
22ER-400ISO	22,00	12,70	4,00	○	○
22ER-450ISO	22,00	12,70	4,50	○	○
22ER-500ISO	22,00	12,70	5,00	○	○
27ER-500ISO	27,00	15,87	5,00	○	○
27ER-550ISO	27,00	15,87	5,50	○	○
27ER-600ISO	27,00	15,87	6,00	○	○
27ER-800ISO	27,00	15,87	8,00	○	○

## EL-ISO

Mechanical thread forms - External inserts **ISO (full form) BS36**  
Mechanische Gewindeformen / **ISO (Vollprofil) BS36** Wendeschneidplatten zum Außendrehen

Reference / Bezeichnung	l	d	p	TIN25	TL20
16EL-100ISO	16,00	9,52	1,00	○	○
16EL-125ISO	16,00	9,52	1,25	○	○
16EL-150ISO	16,00	9,52	1,50	○	○
16EL-175ISO	16,00	9,52	1,75	○	○
16EL-200ISO	16,00	9,52	2,00	○	○
16EL-250ISO	16,00	9,52	2,50	○	○
16EL-300ISO	16,00	9,52	3,00	○	○
22EL-400ISO	22,00	12,70	4,00	○	○



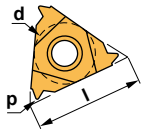

**NR-ISO**

Mechanical thread forms - Internal inserts **ISO (full form) BS36**  
Mechanische Gewindeformen / **ISO (Vollprofil) BS36** Wendeschneidplatten zum Innendrehen

Reference / Bezeichnung	l	d	p	TIN25	TL20
06NR-050ISO	6,00	3,96	0,50	○	
06NR-075ISO	6,00	3,96	0,75	○	
06NR-100ISO	6,00	3,96	1,00	○	
06NR-125ISO	6,00	3,96	1,25	○	
08NR-050ISO	8,00	4,76	0,50	○	
08NR-075ISO	8,00	4,76	0,75	○	
08NR-100ISO	8,00	4,76	1,00	○	
08NR-125ISO	8,00	4,76	1,25	○	
08NR-150ISO	8,00	4,76	1,50	○	
08NR-175ISO	8,00	4,76	1,75	○	
11NR-035ISO	11,00	6,35	0,35	○	
11NR-040ISO	11,00	6,35	0,40	○	
11NR-045ISO	11,00	6,35	0,45	○	
11NR-050ISO	11,00	6,35	0,50	○	
11NR-060ISO	11,00	6,35	0,60	○	
11NR-070ISO	11,00	6,35	0,70	○	
11NR-075ISO	11,00	6,35	0,75	○	
11NR-080ISO	11,00	6,35	0,80	○	
11NR-100ISO	11,00	6,35	1,00	○	
11NR-125ISO	11,00	6,35	1,25	○	
11NR-150ISO	11,00	6,35	1,50	○	
11NR-175ISO	11,00	6,35	1,75	○	
11NR-200ISO	11,00	6,35	2,00	○	
11NR-250ISO	11,00	6,35	2,50	○	
16NR-075ISO	16,00	9,52	0,75	○	
16NR-100ISO	16,00	9,52	1,00	○	
16NR-125ISO	16,00	9,52	1,25	○	
16NR-150ISO	16,00	9,52	1,50	○	
16NR-175ISO	16,00	9,52	1,75	○	
16NR-200ISO	16,00	9,52	2,00	○	
16NR-250ISO	16,00	9,52	2,50	○	
16NR-300ISO	16,00	9,52	3,00	○	
22NR-350ISO	22,00	12,70	3,50	○	
22NR-400ISO	22,00	12,70	4,00	○	
22NR-450ISO	22,00	12,70	4,50	○	
22NR-500ISO	22,00	12,70	5,00	○	
27NR-500ISO	27,00	15,87	5,00	○	
27NR-550ISO	27,00	15,87	5,50	○	
27NR-600ISO	27,00	15,87	6,00	○	
27NR-800ISO	27,00	15,87	8,00	○	



NL ISO

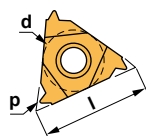

NL

## NL-ISO

Mechanical thread forms - Internal inserts **ISO (full form) BS36**  
Mechanische Gewindeformen / **ISO (Vollprofil) BS36** Wendeschneidplatten zum Innendrehen

Reference / Bezeichnung	l	d	p	TIN25	TL20
06NL-050ISO	6,00	3,96	0,50	○	
06NL-075ISO	6,00	3,96	0,75	○	
06NL-100ISO	6,00	3,96	1,00	○	
06NL-125ISO	6,00	3,96	1,25	○	
08NL-050ISO	8,00	4,76	0,50	○	
08NL-075ISO	8,00	4,76	0,75	○	
08NL-100ISO	8,00	4,76	1,00	○	
08NL-125ISO	8,00	4,76	1,25	○	
08NL-150ISO	8,00	4,76	1,50	○	
08NL-175ISO	8,00	4,76	1,75	○	
11NL-100ISO	11,00	6,35	1,00	○	
11NL-150ISO	11,00	6,35	1,50	○	
16NL-100ISO	16,00	9,52	1,00	○	
16NL-125ISO	16,00	9,52	1,25	○	
16NL-150ISO	16,00	9,52	1,50	○	
16NL-175ISO	16,00	9,52	1,75	○	
16NL-200ISO	16,00	9,52	2,00	○	
16NL-250ISO	16,00	9,52	2,50	○	
16NL-300ISO	16,00	9,52	3,00	○	
22NL-400ISO	22,00	12,70	4,00	○	



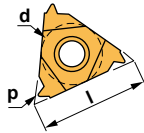

ER

**ER-W**

Mechanical thread forms - External and internal inserts **WHITWORTH (full form) BS84**  
Mechanische Gewindeformen / **WHITWORTH (Vollprofil) BS84** Wendeschneidplatten zum Außen- und Innendreihen

Reference / Bezeichnung	l	d	p	TIN25	TL20
11ER-14W	11,00	6,35	14,0	○	
11ER-16W	11,00	6,35	16,0	○	
11ER-18W	11,00	6,35	18,0	○	
11ER-19W	11,00	6,35	19,0	○	
11ER-22W	11,00	6,35	22,0	○	
11ER-24W	11,00	6,35	24,0	○	
11ER-26W	11,00	6,35	26,0	○	
11ER-28W	11,00	6,35	28,0	○	
11ER-40W	11,00	6,35	40,0	○	
11ER-50W	11,00	6,35	50,0	○	
11ER-56W	11,00	6,35	56,0	○	
16ER-8W	16,00	9,52	8,0	○	
16ER-9W	16,00	9,52	9,0	○	
16ER-10W	16,00	9,52	10,0	○	
16ER-11W	16,00	9,52	11,0	○	
16ER-12W	16,00	9,52	12,0	○	
16ER-14W	16,00	9,52	14,0	○	
16ER-16W	16,00	9,52	16,0	○	
16ER-18W	16,00	9,52	18,0	○	
16ER-19W	16,00	9,52	19,0	○	
16ER-20W	16,00	9,52	20,0	○	
16ER-22W	16,00	9,52	22,0	○	
16ER-24W	16,00	9,52	24,0	○	
16ER-26W	16,00	9,52	26,0	○	
16ER-28W	16,00	9,52	28,0	○	
22ER-4W	22,00	12,70	4,0	○	
22ER-4.5W	22,00	12,70	4,5	○	
22ER-5W	22,00	12,70	5,0	○	
22ER-6W	22,00	12,70	6,0	○	
22ER-7W	22,00	12,70	7,0	○	
22ER-8W	22,00	12,70	8,0	○	
27ER-4W	27,00	15,87	4,0	○	
27ER-4.5W	27,00	15,87	4,5	○	



EL-W

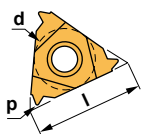

EL

**EL-W**

Mechanical thread forms - External and internal inserts **WHITWORTH (full form) BS84**  
Mechanische Gewindeformen / **WHITWORTH (Vollprofil) BS84** Wendeschneidplatten zum Außen- und Innendreihen

Reference / Bezeichnung	l	d	p	TIN25	TL20
16EL-11W	16,00	9,52	11,0	○	
16EL-14W	16,00	9,52	14,0	○	
16EL-20W	16,00	9,52	20,0	○	



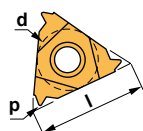

NR

## NR-W

Mechanical thread forms - Internal inserts **WHITWORTH (full form) BS84**  
Mechanische Gewindeformen / **WHITWORTH (Vollprofil) BS84** Wendeschneidplatten zum Innendrehen

Reference / Bezeichnung	l	d	p	TIN25	TL20
06NR-18W	6,00	3,96	18,0	○	○
06NR-19W	6,00	3,96	19,0	○	○
06NR-20W	6,00	3,96	20,0	○	○
06NR-22W	6,00	3,96	22,0	○	○
06NR-26W	6,00	3,96	26,0	○	○
08NR-16W	8,00	4,76	16,0	○	○
08NR-18W	8,00	4,76	18,0	○	○
08NR-19W	8,00	4,76	19,0	○	○
08NR-20W	8,00	4,76	20,0	○	○
08NR-24W	8,00	4,76	24,0	○	○
08NR-28W	8,00	4,76	28,0	○	○
11NR-11W	11,00	6,35	11,0	○	○
11NR-12W	11,00	6,35	12,0	○	○
11NR-14W	11,00	6,35	14,0	○	○
11NR-16W	11,00	6,35	16,0	○	○
11NR-18W	11,00	6,35	18,0	○	○
11NR-19W	11,00	6,35	19,0	○	○
11NR-20W	11,00	6,35	20,0	○	○
11NR-22W	11,00	6,35	22,0	○	○
11NR-24W	11,00	6,35	24,0	○	○
11NR-26W	11,00	6,35	26,0	○	○
11NR-28W	11,00	6,35	28,0	○	○
11NR-32W	11,00	6,35	32,0	○	○
11NR-36W	11,00	6,35	36,0	○	○
11NR-40W	11,00	6,35	40,0	○	○
11NR-48W	11,00	6,35	48,0	○	○
16NR-8W	16,00	9,52	8,0	○	○
16NR-9W	16,00	9,52	9,0	○	○
16NR-10W	16,00	9,52	10,0	○	○
16NR-11W	16,00	9,52	11,0	○	○
16NR-12W	16,00	9,52	12,0	○	○
16NR-14W	16,00	9,52	14,0	○	○
16NR-16W	16,00	9,52	16,0	○	○
16NR-18W	16,00	9,52	18,0	○	○
16NR-19W	16,00	9,52	19,0	○	○
16NR-20W	16,00	9,52	20,0	○	○
16NR-22W	16,00	9,52	22,0	○	○
16NR-24W	16,00	9,52	24,0	○	○
16NR-26W	16,00	9,52	26,0	○	○
16NR-28W	16,00	9,52	28,0	○	○
22NR-4W	22,00	12,70	4,0	○	○
22NR-4.5W	22,00	12,70	4,5	○	○
22NR-5W	22,00	12,70	5,0	○	○
22NR-6W	22,00	12,70	6,0	○	○
22NR-7W	22,00	12,70	7,0	○	○





NL-W

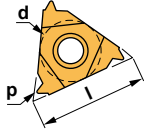

NL

**NL-W**

Mechanische Gewindeformen / **WHITWORTH (Vollprofil) BS84** Wendeschneidplatten zum Innendrehen  
Mechanical thread forms - Internal inserts **WHITWORTH (full form) BS84** Wendeschneidplatten zum Innendrehen

Reference / Bezeichnung	l	d	p	TIN25	TL20
06NL-18W	6,00	3,96	18,0	○	○
06NL-20W	6,00	3,96	20,0	○	○
06NL-22W	6,00	3,96	22,0	○	○
06NL-26W	6,00	3,96	26,0	○	○
08NL-16W	8,00	4,76	16,0	○	○
08NL-18W	8,00	4,76	18,0	○	○
08NL-19W	8,00	4,76	19,0	○	○
08NL-20W	8,00	4,76	20,0	○	○
08NL-24W	8,00	4,76	24,0	○	○
08NL-28W	8,00	4,76	28,0	○	○
16NL-11W	16,00	9,52	11,0	○	○
16NL-14W	16,00	9,52	14,0	○	○
16NL-16W	16,00	9,52	16,0	○	○



ER-LG

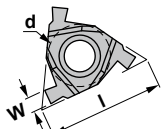

ER

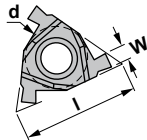

EL

**ER-LG**

External lock ring grooving inserts - Type LG  
Außeneinstechplatten für Sicherungsringnuten Typ LG

Reference / Bezeichnung	l	d	W	TIN25	TL20
16ER-100LG	16,00	9,52	1,15	●	●
16ER-120LG	16,00	9,52	1,35	●	●
16ER-150LG	16,00	9,52	1,65	●	●
16ER-175LG	16,00	9,52	1,90	●	●
16ER-200LG	16,00	9,52	2,15	●	●
16ER-250LG	16,00	9,52	2,65	●	●

**EL-LG**

External lock ring grooving inserts - Type LG  
Außeneinstechplatten für Sicherungsringnuten Typ LG

Reference / Bezeichnung	l	d	W	TIN25	TL20
16EL-100LG	16,00	9,52	1,15	●	●
16EL-120LG	16,00	9,52	1,35	●	●
16EL-150LG	16,00	9,52	1,65	●	●
16EL-175LG	16,00	9,52	1,90	●	●
16EL-200LG	16,00	9,52	2,15	●	●

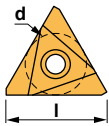

**TNMC**

Triangular negative insert for threading.  
Dreikantige negative Wendeschneidplatte zum Gewindedrehen.

Reference / Bezeichnung	l	s	d	PM25	TN15
TNMC 1603XX	16,50	3,18	9,52	○	○
TNMC 2204XX	22,00	4,76	12,70	●	○

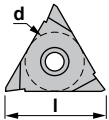
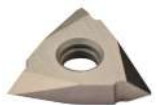

**TPMC**

Triangular positive insert for threading.  
Dreikantige positive Wendeschneidplatte zum Gewindedrehen.

Reference / Bezeichnung	l	s	d	PM25	TN15
TPMC 1603XX	16,50	3,18	9,52	○	○
TPMC 2204XX	22,00	4,76	12,70	○	○

## External threading Außengewindedrehen

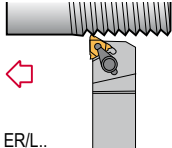
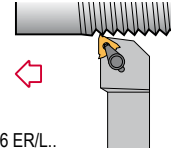
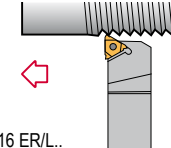
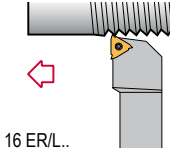
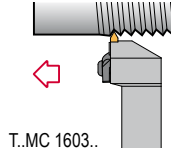
<p><b>CTAN 90°</b></p>  <p>16 ER/L... 22 ER/L... 27 ER/L...</p> <p>Page Seite C12</p>	<p><b>CTXN 90°</b></p>  <p>16 ER/L... 22 ER/L... 27 ER/L...</p> <p>Page Seite C13</p>	<p><b>STAN 90°</b></p>  <p>16 ER/L... 22 ER/L... 27 ER/L...</p> <p>Page Seite C14</p>	<p><b>STXN 90°</b></p>  <p>16 ER/L... 22 ER/L... 27 ER/L...</p> <p>Page Seite C15</p>	<p><b>STCN 90°</b></p>  <p>T..MC 1603.. T..MC 2204.. T..MC 2706..</p> <p>Page Seite C16</p>
--	--	--	---	--

## Internal threading Innengewindedrehen

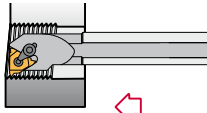
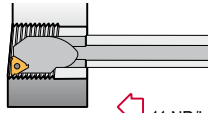
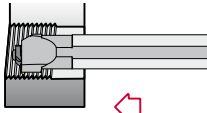
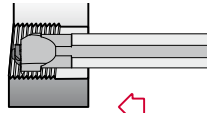
<p><b>CTXN 90°</b></p>  <p>Page Seite C17</p> <p>16 NR/L... 22 NR/L... 27 NR/L...</p>	<p><b>STXN 90°</b></p>  <p>Page Seite C18</p> <p>11 NR/L... 16 NR/L... 22 NR/L... 27 NR/L...</p>	<p><b>STGN 90°</b></p>  <p>Page Seite C19</p> <p>TNMC 1603.. TNMC 2204.. TNMC 2706..</p>	<p><b>STGP 90°</b></p>  <p>Page Seite C20</p> <p>TPMC 1603.. TPMC 2204..</p>	
--	---	---	--	--





**Characteristics:**  
Multipurpose top clamp threading toolholder for negative lay down inserts.

**Eigenschaften:**  
Multifunktionaler Klemmhalter mit oberer Klemmung zum Außengewindedrehen für negative Gewindeplatten.

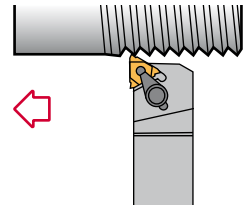
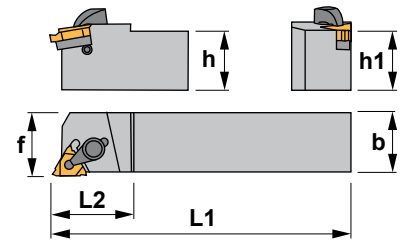

## CTAN 90°

Reference Bezeichnung	h=h1	b	L1	L2	f	Insert size Wendeschnidplatte	Kg
CTAN R/L 2020 K16	20	20	125	28	20	16 ER/L..	0,400
CTAN R/L 2525 M16	25	25	150	28	25	16 ER/L..	0,700
CTAN R/L 3232 P16	32	32	170	28	32	16 ER/L..	1,050
CTAN R/L 2525 M22	25	25	150	34	25	22 ER/L..	0,700
CTAN R/L 3232 P22	32	32	170	34	32	22 ER/L..	1,300
CTAN R/L 4040 R22	40	40	200	36	40	22 ER/L..	3,000
CTAN R/L 3232 P27	32	32	170	34	32	27 ER/L..	1,300
CTAN R/L 4040 R27	40	40	200	40	40	27 ER/L..	3,000
CTAN R/L 5050 S27	50	50	250	40	50	27 ER/L..	5,800

**WARNING!!** Because of large thread profile, modification may have to be made to the toolholder to achieve full depth of thread.  
**ACHTUNG!!** Bei großen Gewindeprofilen eine Änderung im Klemmhalter könnte erforderlich sein, um die volle Gewindetiefe zu erreichen.

Reference Bezeichnung								Nm
CTAN R/L 2020 K16	2516	5515	5510	YE3	YI3	SY3	SA3	2.0
CTAN R/L 2525 M16	2516	5515	5510	YE3	YI3	SY3	SA3	2.0
CTAN R/L 3232 P16	2516	5515	-	YE3	YI3	SY3	SA3	-
CTAN R/L 2525 M22	2522	5515	5520	YE4	YI4	SY4	SA4	4.0
CTAN R/L 3232 P22	2522	5515	5520	YE4	YI4	SY4	SA4	4.0
CTAN R/L 4040 R22	2522	5515	5520	YE4	YI4	SY4	SA4	4.0
CTAN R/L 3232 P27	2527	5525	-	YE5	YI5	SY5	SA5	-
CTAN R/L 4040 R27	2527	5525	-	YE5	YI5	SY5	SA5	-
CTAN R/L 5050 S27	2527	5525	-	YE5	YI5	SY5	SA5	-

Optional

### E R/L

Triangular negative inserts for external threading. Dreieckige negative Wendeschnidplatten zum Außengewindedrehen. C03,05,08,10

Reference / Bez.

l

d

16 ER/L..

16,00

9,52

22 ER/L..

22,00

12,70

27 ER/L..

27,50

15,88

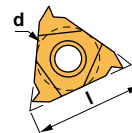

E R/L

E R/L TD



ER/L-LG





**Characteristics:**  
Multipurpose top clamp threading toolholder for negative lay down inserts.

**Eigenschaften:**  
Multifunktionaler Klemmhalter mit oberer Klemmung zum Außengewindedrehen für negative Gewindeplatten.

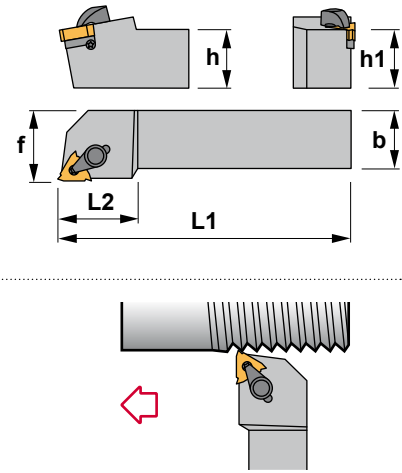

## CTXN 90°

Reference Bezeichnung	h=h1	b	L1	L2	f	Insert size Wendschneidplatte	kg
CTXN R/L 1212 F16	12	12	80	25	16	16 ER/L..	0,100
CTXN R/L 1616 H16	16	16	100	25	20	16 ER/L..	0,200
CTXN R/L 2020 K16	20	20	125	28	25	16 ER/L..	0,400
CTXN R/L 2525 M16	25	25	150	28	32	16 ER/L..	0,700
CTXN R/L 3232 P16	32	32	170	28	40	16 ER/L..	1,050
CTXN R/L 2525 M22	25	25	150	34	32	22 ER/L..	0,700
CTXN R/L 3232 P22	32	32	170	34	40	22 ER/L..	1,300
CTXN R/L 4040 R22	40	40	200	36	50	22 ER/L..	3,000
CTXN R/L 2525 M27	25	25	150	34	32	27 ER/L..	0,700
CTXN R/L 3232 P27	32	32	170	34	40	27 ER/L..	1,300
CTXN R/L 4040 R27	40	40	200	40	50	27 ER/L..	3,000
CTXN R/L 5050 S27	50	50	250	50	60	27 ER/L..	5,800

**WARNING!!** Because of large thread profile, modification may have to be made to the toolholder to achieve full depth of thread.  
**ACHTUNG!!** Bei großen Gewindeprofilen eine Änderung im Klemmhalter könnte erforderlich sein, um die volle Gewindetiefe zu erreichen.

Reference Bezeichnung							Nm
CTXN R/L 1212 F16	2516	5515	YE3	YI3	SY3	SA3	3.0
CTXN R/L 1616 H16	2516	5515	YE3	YI3	SY3	SA3	3.0
CTXN R/L 2020 K16	2516	5515	YE3	YI3	SY3	SA3	3.0
CTXN R/L 2525 M16	2516	5515	YE3	YI3	SY3	SA3	3.0
CTXN R/L 3232 P16	2516	5515	YE3	YI3	SY3	SA3	3.0
CTXN R/L 2525 M22	2522	5515	YE4	YI4	SY4	SA4	3.0
CTXN R/L 3232 P22	2522	5515	YE4	YI4	SY4	SA4	3.0
CTXN R/L 4040 R22	2522	5515	YE4	YI4	SY4	SA4	3.0
CTXN R/L 2525 M27	2527	5525	YE5	YI5	SY5	SA5	5.0
CTXN R/L 3232 P27	2527	5525	YE5	YI5	SY5	SA5	5.0
CTXN R/L 4040 R27	2527	5525	YE5	YI5	SY5	SA5	5.0
CTXN R/L 5050 S27	2527	5525	YE5	YI5	SY5	SA5	5.0

Optional

### E R/L

Triangular negative inserts for external threading.  
Dreikantige negative Wendschneidplatten zum Außengewindedrehen. ⓘ C03,05,08,10

Reference / Bez.	l	d
16 ER/L..	16,00	9,52
22 ER/L..	22,00	12,70
27 ER/L..	27,50	15,88

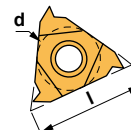

E R/L	E R/L TD
<b>ER/L-LG</b>	



**Characteristics:**  
Multipurpose threading toolholder for negative lay down inserts.

**Eigenschaften:**  
Multifunktionaler Klemmhalter zum Gewindedrehen für negative Gewindeplatten.

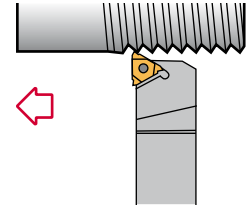
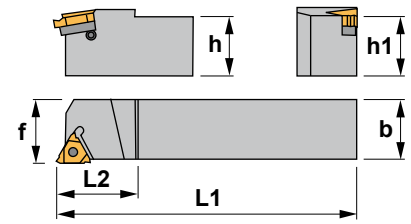

## STAN 90°

Reference Bezeichnung	h=h1	b	L1	L2	f	Insert size Wendeschneidplatte	
STAN R/L 1616 H16	16	16	100	22	16	16 ER/L..	0,070
STAN R/L 2020 K16	20	20	125	28	20	16 ER/L..	0,100
STAN R/L 2525 M16	25	25	150	28	25	16 ER/L..	0,140
STAN R/L 3232 P16	32	32	170	28	32	16 ER/L..	0,200
STAN R/L 2525 M22	25	25	150	34	25	22 ER/L..	0,270
STAN R/L 3232 P22	32	32	175	34	32	22 ER/L..	0,400
STAN R/L 4040 R22	40	40	200	34	40	22 ER/L..	0,700
STAN R/L 3232 P27	32	32	170	34	32	27 ER/L..	1,300
STAN R/L 4040 R27	40	40	200	34	40	27 ER/L..	0,700
STAN R/L 5050 S27	50	50	250	34	50	27 ER/L..	1,300

**WARNING!!** Because of large thread profile, modification may have to be made to the toolholder to achieve full depth of thread.  
**ACHTUNG!!** Bei großen Gewindeprofilen eine Änderung im Klemmhalter könnte erforderlich sein, um die volle Gewindetiefe zu erreichen.

Reference Bezeichnung			 R	 L		Nm
STAN R/L 1616 H16	SA3	5510	YE3	YI3	SY3	2.0
STAN R/L 2020 K16	SA3	5510	YE3	YI3	SY3	2.0
STAN R/L 2525 M16	SA3	5510	YE3	YI3	SY3	2.0
STAN R/L 3232 P16	SA3	5510	YE3	YI3	SY3	2.0
STAN R/L 2525 M22	SA4	5520	YE4	YI4	SY4	4.0
STAN R/L 3232 P22	SA4	5520	YE4	YI4	SY4	4.0
STAN R/L 4040 R22	SA4	5520	YE4	YI4	SY4	4.0
STAN R/L 3232 P27	SA5	5525	YE5	YI5	SY5	5.0
STAN R/L 4040 R27	SA5	5525	YE5	YI5	SY5	5.0
STAN R/L 5050 S27	SA5	5525	YE5	YI5	SY5	5.0

### E R/L

Triangular negative inserts for external threading.  
Dreikantige negative Wendeschneidplatten zum Außengewindedrehen.  C03,05,08,10

Reference / Bez.	l	d
16 ER/L..	16,00	9,52
22 ER/L..	22,00	12,70
27 ER/L..	27,50	15,88

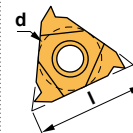



**Characteristics:**  
Multipurpose threading toolholder for negative lay down inserts.

**Eigenschaften:**  
Multifunktionaler Klemmhalter zum Gewindedrehen für negative Gewindeplatten.

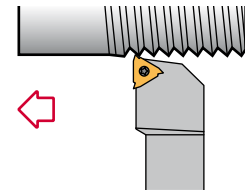
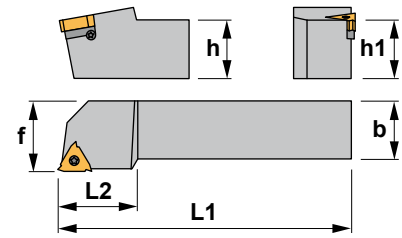

## STXN 90°

Reference Bezeichnung	h=h1	b	L1	L2	f	Insert size Wendeschneidplatte	
STXN R/L 1212 F16	12	12	80	25	16	16 ER/L..	0,100
STXN R/L 1616 H16	16	16	100	25	20	16 ER/L..	0,200
STXN R/L 2020 K16	20	20	125	28	25	16 ER/L..	0,400
STXN R/L 2525 M16	25	25	150	28	32	16 ER/L..	0,700
STXN R/L 3232 P16	32	32	170	28	40	16 ER/L..	1,050
STXN R/L 2525 M22	25	25	150	34	32	22 ER/L..	0,700
STXN R/L 3232 P22	32	32	170	34	40	22 ER/L..	1,300
STXN R/L 4040 R22	40	40	200	34	50	22 ER/L..	3,000
STXN R/L 2525 M27	25	25	150	34	32	27 ER/L..	0,700
STXN R/L 3232 P27	32	32	170	34	40	27 ER/L..	1,300
STXN R/L 4040 R27	40	40	200	34	50	27 ER/L..	3,000
STXN R/L 5050 S27	50	50	250	34	60	27 ER/L..	5,800

**WARNING!!** Because of large thread profile, modification may have to be made to the toolholder to achieve full depth of thread.  
**ACHTUNG!!** Bei großen Gewindeprofilen eine Änderung im Klemmhalter könnte erforderlich sein, um die volle Gewindetiefe zu erreichen.

Reference Bezeichnung						Nm
STXN R/L 1212 F16	SA3T	5510	YE3	YI3	SY3	2.0
STXN R/L 1616 H16	SA3	5510	YE3	YI3	SY3	2.0
STXN R/L 2020 K16	SA3	5510	YE3	YI3	SY3	2.0
STXN R/L 2525 M16	SA3	5510	YE3	YI3	SY3	2.0
STXN R/L 3232 P16	SA3	5510	YE3	YI3	SY3	2.0
STXN R/L 2525 M22	SA4	5520	YE4	YI4	SY4	4.0
STXN R/L 3232 P22	SA4	5520	YE4	YI4	SY4	4.0
STXN R/L 4040 R22	SA4	5520	YE4	YI4	SY4	4.0
STXN R/L 2525 M27	SA5	5525	YE5	YI5	SY5	5.0
STXN R/L 3232 P27	SA5	5525	YE5	YI5	SY5	5.0
STXN R/L 4040 R27	SA5	5525	YE5	YI5	SY5	5.0
STXN R/L 5050 S27	SA5	5525	YE5	YI5	SY5	5.0

### E R/L

Triangular negative inserts for external threading. Dreikantige negative Wendeschneidplatten zum Außengewindedrehen. C03,05,08,10

Reference / Bez.	l	d
16 ER/L..	16,00	9,52
22 ER/L..	22,00	12,70
27 ER/L..	27,50	15,88

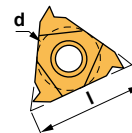



Characteristics:  
Vertical on edge threading toolholder.

Eigenschaften:  
Klemmhalter zum Vertikal-Gewindedrehen  
auf der Kante.

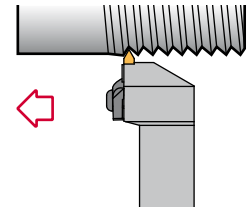
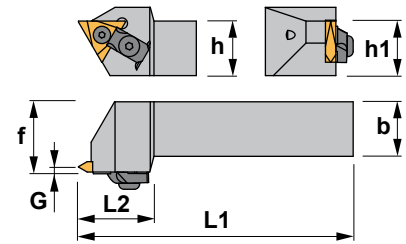

## STCN 90°

Reference Bezeichnung	h=h1	b	L1	L2	f	G	Insert size Wendeschneidplatte	⚖ Kg
STCN R/L 1212 F16	12	12	80	25	16	1,59	TNMC/TPMC 1603..	0,100
STCN R/L 1616 H16	16	16	100	25	19	1,59	TNMC/TPMC 1603..	0,200
STCN R/L 2020 K16	20	20	125	28	22	1,59	TNMC/TPMC 1603..	0,400
STCN R/L 2525 M16	25	25	150	34	32	1,59	TNMC/TPMC 1603..	0,700
STCN R/L 3232 P16	32	32	170	34	38	1,59	TNMC/TPMC 1603..	1,050
STCN R/L 2020 K22	20	20	125	34	22	2,38	TNMC/TPMC 2204..	0,400
STCN R/L 2525 M22	25	25	150	34	32	2,38	TNMC/TPMC 2204..	0,700
STCN R/L 3225 P22	32	25	170	34	32	2,38	TNMC/TPMC 2204..	1,025
STCN R/L 3232 P22	32	32	170	34	38	2,38	TNMC/TPMC 2204..	1,050
STCN R/L 2525 M27	25	25	150	38	32	2,38	TNMC/TPMC 2706..	0,700
STCN R/L 3232 P27	32	32	170	42	38	2,38	TNMC/TPMC 2706..	1,050

Reference Bezeichnung						Nm <sup>1</sup>	Nm <sup>2</sup>
STCN R/L 1212 F16	1935	-	-	-	-	-	-
STCN R/L 1616 H16	1935	-	-	-	-	-	-
STCN R/L 2020 K16	1935	2101	1815	5003	5002	3.0	1.4
STCN R/L 2525 M16	1935	2101	1815	5003	5002	3.0	1.4
STCN R/L 3232 P16	1935	2101	1815	5003	5002	3.0	1.4
STCN R/L 2020 K22	1950	2101	1815	5003	5025	3.0	2.0
STCN R/L 2525 M22	1950	2101	1815	5003	5025	3.0	2.0
STCN R/L 3225 P22	1950	2101	1815	5003	5025	3.0	2.0
STCN R/L 3232 P22	1950	2101	1815	5003	5025	3.0	2.0
STCN R/L 2525 M27	1955	2101	1815	-	5003	3.0	3.0
STCN R/L 3232 P27	1955	2101	1815	-	5003	3.0	3.0

### TNMC/TPMC

Triangular negative and positive inserts for external threading. C10  
Dreikantige negative und positive WSP zum Außengewindedrehen.

Reference / Bez.	l	s	d
T..MC 1603..	16,50	3,18	9,52
T..MC 2204..	22,00	4,76	12,70
T..MC 2706..	27,00	6,35	15,88

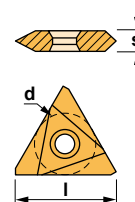

#### TNMC



#### TPMC







**Characteristics:**

Multipurpose top clamp threading boring bar for negative lay down inserts.

**Eigenschaften:**

Multifunktionale Bohrstanze mit oberer Klemmung zum Innengewindedrehen für negative Gewindeplatten.

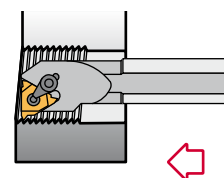
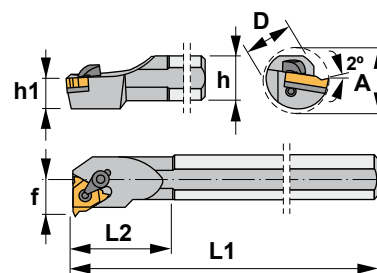

## CTXN 90°

Reference Bezeichnung	D	h	h1	L1	L2	f	A	Insert size Wendeschneidplatte	kg
S20Q CTXN R/L 16	20	18	9,0	180	35	13,0	24	16 NR/L..	0,400
S25R CTXN R/L 16	25	23	11,5	200	40	17,0	29	16 NR/L..	0,700
S32S CTXN R/L 16	32	30	15,0	250	45	22,0	36	16 NR/L..	1,500
S40T CTXN R/L 16	40	37	18,5	300	50	27,0	44	16 NR/L..	2,850
S25R CTXN R/L 22	25	23	11,5	200	40	17,0	32	22 NR/L..	0,700
S32S CTXN R/L 22	32	30	15,0	250	45	22,0	39	22 NR/L..	1,500
S40T CTXN R/L 22	40	37	18,5	300	50	27,0	47	22 NR/L..	2,850
S32S CTXN R/L 27	32	30	15,0	250	45	22,4	40	27 NR/L..	1,500
S40T CTXN R/L 27	40	37	18,5	300	50	26,4	48	27 NR/L..	2,850
S50U CTXN R/L 27	50	47	23,5	350	60	31,4	58	27 NR/L..	5,200
S60V CTXN R/L 27	60	58	29,0	400	60	36,4	69	27 NR/L..	8,550

**WARNING!!** Because of large thread profile, modification may have to be made to the boring bar to achieve full depth of thread.  
**ACHTUNG!!** Bei großen Gewindeprofilen eine Änderung in der Bohrstanze könnte erforderlich sein, um die volle Gewindetiefe zu erreichen.

Reference Bezeichnung			R	L			Nm
S20Q CTXN R/L 16	2516	5515	YI3	YE3	SY3	SN3	3.0
S25R CTXN R/L 16	2516	5515	YI3	YE3	SY3	SA3	3.0
S32S CTXN R/L 16	2516	5515	YI3	YE3	SY3	SA3	3.0
S40T CTXN R/L 16	2516	5515	YI3	YE3	SY3	SA3	3.0
S25R CTXN R/L 22	2522	5515	YI4	YE4	SY4	SA4	3.0
S32S CTXN R/L 22	2522	5515	YI4	YE4	SY4	SA4	3.0
S40T CTXN R/L 22	2522	5515	YI4	YE4	SY4	SA4	3.0
S32S CTXN R/L 27	2527	5525	YI5	YE5	SY5	SA5	5.0
S40T CTXN R/L 27	2527	5525	YI5	YE5	SY5	SA5	5.0
S50U CTXN R/L 27	2527	5525	YI5	YE5	SY5	SA5	5.0
S60V CTXN R/L 27	2527	5525	YI5	YE5	SY5	SA5	5.0

Optional

### N R/L

Triangular negative inserts for internal threading.  
Dreikantige negative Wendeschneidplatten zum Innengewindedrehen. C04,06,07,09,10

Reference / Bez.

l

d

16 NR/L..	16,00	9,52
22 NR/L..	22,00	12,70
27 NR/L..	27,00	15,87

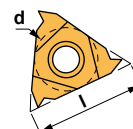

N R/L



N R/L TD





**Characteristics:**

Multipurpose threading boring bar for negative lay down inserts.

**Eigenschaften:**

Multifunktionale Bohrstanze zum Gewindedrehen für negative Gewindeplatten.

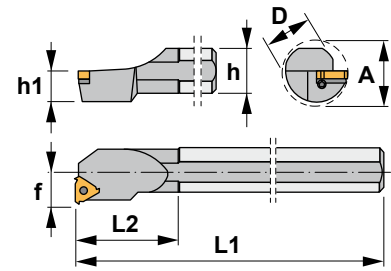
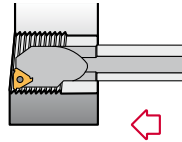

# STXN 90°

Reference Bezeichnung	D	h	h1	L1	L2	f	A	Insert size Wendeschneidplatte	KG
S10K STXN R/L 11	10	9	4,5	125	16	7,3	13	11 NR/L..	0,070
S16M STXN R/L 11	16	15	7,5	150	25	8,9	16	11 NR/L..	0,200
S16M STXN R/L 16	16	15	7,5	150	30	11,5	20	16 NR/L..	0,200
S20Q STXN R/L 16	20	18	9,0	180	35	13,4	24	16 NR/L..	0,400
S25R STXN R/L 16	25	23	11,5	200	40	16,3	29	16 NR/L..	0,700
S32S STXN R/L 16	32	30	15,0	250	45	19,6	36	16 NR/L..	1,500
S40T STXN R/L 16	40	37	18,5	300	50	23,8	44	16 NR/L..	2,850
S20Q STXN R/L 22	20	18	9,0	180	35	15,6	27	22 NR/L..	0,400
S25R STXN R/L 22	25	23	11,5	200	40	17,2	32	22 NR/L..	0,700
S32S STXN R/L 22	32	30	15,0	250	45	21,5	39	22 NR/L..	1,500
S40T STXN R/L 22	40	37	18,5	300	50	25,8	47	22 NR/L..	2,850
S32S STXN R/L 27	32	30	15,0	250	45	22,4	40	27 NR/L..	1,500
S40T STXN R/L 27	40	37	18,5	300	50	26,4	48	27 NR/L..	2,850
S50U STXN R/L 27	50	47	23,5	350	60	31,4	58	27 NR/L..	5,200
S60V STXN R/L 27	60	57	28,5	400	60	36,4	69	27 NR/L..	8,550

**WARNING!!** Because of large thread profile, modification may have to be made to the boring bar to achieve full depth of thread.

**ACHTUNG!!** Bei großen Gewindeprofilen eine Änderung in der Bohrstanze könnte erforderlich sein, um die volle Gewindetiefe zu erreichen.

Reference Bezeichnung						Nm
S10K STXN R/L 11	1225	5507	-	-	-	0.9
S16M STXN R/L 11	1225	5507	-	-	-	0.9
S16M STXN R/L 16	SN3	5510	-	-	-	2.0
S20Q STXN R/L 16	SA3T	5510	YI3	YE3	SY3	2.0
S25R STXN R/L 16	SA3	5510	YI3	YE3	SY3	2.0
S32S STXN R/L 16	SA3	5510	YI3	YE3	SY3	2.0
S40T STXN R/L 16	SA3	5510	YI3	YE3	SY3	2.0
S20Q STXN R/L 22	SN4	5520	-	-	-	4.0
S25R STXN R/L 22	SA4	5520	YI4	YE4	SY4	4.0
S32S STXN R/L 22	SA4	5520	YI4	YE4	SY4	4.0
S40T STXN R/L 22	SA4	5520	YI4	YE4	SY4	4.0
S32S STXN R/L 27	SA5	5525	YI5	YE5	SY5	5.0
S40T STXN R/L 27	SA5	5525	YI5	YE5	SY5	5.0
S50U STXN R/L 27	SA5	5525	YI5	YE5	SY5	5.0
S60V STXN R/L 27	SA5	5525	YI5	YE5	SY5	5.0

## N R/L

Triangular negative inserts for internal threading. Dreieckige negative Wendeschneidplatten zum Innengewindedrehen. ⓘ C04,06,07,09,10

Reference / Bez.

l

d

11 NR/L..	11,00	6,35
16 NR/L..	16,00	9,52
22 NR/L..	22,00	12,70
27 NR/L..	27,00	15,87

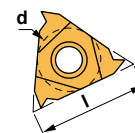

N R/L



N R/L TD





Characteristics:  
Vertical on edge threading boring bar.

Eigenschaften:  
Bohrstange zum Vertikal-Gewindedrehen auf der Kante.

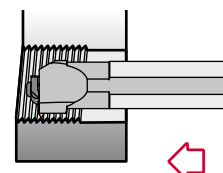
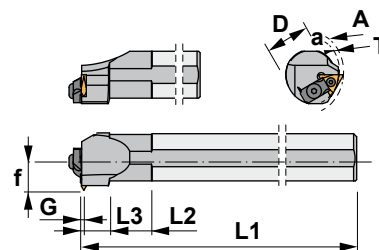

## STGN 90°

Reference Bezeichnung	D	L1	L2	L3	f	A	a	T	G	Insert size Wendeschneidplatte	Kg
S32U STGN R/L 16	32	350	45	19	21,0	50,4	45	2,7	1,59	TNMC 1603..	2,100
S40V STGN R/L 16	40	400	50	19	25,0	60,4	55	2,7	1,59	TNMC 1603..	3,650
S32U STGN R/L 22	32	350	45	28	21,0	78,2	70	4,1	2,38	TNMC 2204..	2,100
S40V STGN R/L 22	40	400	50	28	25,0	50,4	45	4,1	2,38	TNMC 2204..	3,650
S50W STGN R/L 22	50	450	60	28	36,5	60,4	55	4,1	2,38	TNMC 2204..	6,700
S40V STGN R/L 27	40	400	50	28	25,0	60,4	55	6,0	3,18	TNMC 2706..	3,650
S50W STGN R/L 27	50	450	60	28	36,5	78,2	70	6,0	3,18	TNMC 2706..	6,700

Reference Bezeichnung						Nm <sup>1</sup>	Nm <sup>2</sup>
S32U STGN R/L 16	1935	2101	1815	5002	5003	1.4	3.0
S40V STGN R/L 16	1935	2101	1815	5002	5003	1.4	3.0
S32U STGN R/L 22	1950	2101	1815	5025	5003	2.0	3.0
S40V STGN R/L 22	1950	2101	1815	5025	5003	2.0	3.0
S50W STGN R/L 22	1950	2101	1815	5025	5003	2.0	3.0
S40V STGN R/L 27	1955	2101	1815	5003	5003	3.0	3.0
S50W STGN R/L 27	1955	2101	1815	5003	5003	3.0	3.0

### TNMC

Triangular negative insert for internal threading. C10  
Dreikantige negative Wendeschneidplatte zum Innengewindedrehen.

Reference / Bez.

	l	s	d
TNMC 1603..	16,50	3,18	9,52
TNMC 2204..	22,00	4,76	12,70
TNMC 2706..	27,00	6,35	15,88

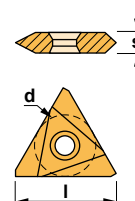

TNMC





Characteristics:  
Vertical on edge threading boring bar.

Eigenschaften:  
Bohrstange zum Vertikal-Gewindedrehen  
auf der Kante.

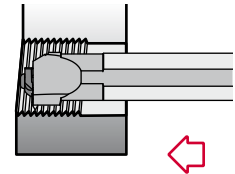
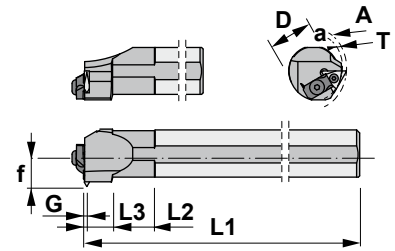

## STGP 90°

Reference Bezeichnung	D	L1	L2	L3	f	A	a	T	G	Insert size Wendeschneidplatte	Kg
S25T STGP R/L 16	25	300	40	19	17,5	50,4	45	2,7	1,59	TPMC 1603..	1,100
S32U STGP R/L 16	32	350	45	19	20,5	50,4	45	2,7	1,59	TPMC 1603..	2,100
S40V STGP R/L 22	40	400	50	28	25,0	78,2	70	4,1	2,38	TPMC 2204..	3,650
S50W STGP R/L 22	50	450	60	28	36,5	78,2	70	4,1	2,38	TPMC 2204..	6,700

Reference Bezeichnung						Nm <sup>1</sup>	Nm <sup>2</sup>
S25T STGP R/L 16	1935	2101	1815	5002	5003	1.4	3.0
S32U STGP R/L 16	1935	2101	1815	5002	5003	1.4	3.0
S40V STGP R/L 22	1950	2101	1815	5025	5003	2.0	3.0
S50W STGP R/L 22	1950	2101	1815	5025	5003	2.0	3.0

### TPMC

Triangular positive insert for internal threading. C10  
Dreikantige positive Wendeschneidplatte zum Innengewindedrehen.

Reference / Bez.	l	s	d
TPMC 1603..	16,50	3,18	9,52
TPMC 2204..	22,00	4,76	12,70

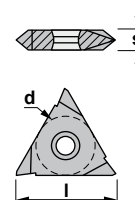

### TPMC

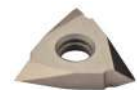

## Cutting data

Material	Cutting speed m/min. (Ft/min) Insert grade			N° of passes		
	PM25	KM15	TIN25	P mm	TPI	N° of passes
Low and medium carbon steel	120-80 (390-260)		250-210 (820-690)	0,50 0,75 1,00 1,25 1,50 1,75 2,00 2,50 3,00	48,0 32,0 24,0 20,0 16,0 14,0 12,0 10,0 8,0	4 - 6 4 - 7 4 - 8 5 - 9 6 - 10 7 - 12 7 - 12 8 - 14 10 - 18
High carbon steel	110-70 (360-230)		210-150 (690-490)	3,50 4,00 4,50 5,00 5,50 6,00 8,00	7,0 6,0 5,5 5,0 4,5 4,0 3,0	11 - 18 11 - 18 11 - 19 12 - 20 12 - 20 12 - 20 15 - 24
Alloyed tool steel and heat-treated steels	100-70 (360-230)		180-140 (590-460)			
Stainless steels	100-70 (360-230)	90-70 (295-230)	140-110 (460-360)			
Cast-iron HB 180-250		90-70 (295-230)				
Non-ferrous metals		180-120 (590-390)				

### General recommendations:

- Threading speeds should normally be a minimum of 80% to 90% of turning speeds being used to machine the same component (assuming grades are compatible).
- Check helix angle and number of passes shown in charts before starting.
- Ensure centre height is correct.
- When there is a problem consult the following recommendations and change only one variable at a time. This will help to be sure of the original problem.
- Do not use flank infeed on work hardening materials.

## Component problems

Problem	Remedy
<b>Pitch error (on CNC machines)</b> <ul style="list-style-type: none"> <li>▼ Starting too close to workpiece.</li> <li>▼ Saddle speed towards chuck is excessive.</li> </ul>	<ul style="list-style-type: none"> <li>▲ Start cycle further back from workpiece.</li> <li>▲ Reduce speed by 10% until correct.</li> </ul>
<b>Thread torn on one side only</b> <ul style="list-style-type: none"> <li>▼ Incorrect helix angle in toolholder.</li> </ul>	<ul style="list-style-type: none"> <li>▲ Check helix chart.</li> <li>▲ Reassemble with correct anvil.</li> <li>▲ Check centre height.</li> </ul>
<b>Thread torn on both sides</b> <ul style="list-style-type: none"> <li>▼ Running too slow.</li> <li>▼ Built up edge.</li> </ul>	<ul style="list-style-type: none"> <li>▲ Increase cutting speed.</li> <li>▲ Check center height.</li> <li>▲ Use coated grade.</li> <li>▲ Compare thread speed with turning speed.</li> </ul>
<b>Long dangerous swarf</b> <ul style="list-style-type: none"> <li>▼ Incorrect chipbreaker geometry.</li> <li>▼ Incorrect method of infeed.</li> </ul>	<ul style="list-style-type: none"> <li>▲ Use Canela (TD) chipbreaker.</li> <li>▲ Use different infeed method.</li> </ul>
<b>Vibration chatter marks on both flanks</b> <ul style="list-style-type: none"> <li>▼ Poor stability.</li> <li>▼ Excessive overhang.</li> </ul>	<ul style="list-style-type: none"> <li>▲ Renew anvil to support insert.</li> <li>▲ Check tool clamping.</li> <li>▲ Reduce tool overhang.</li> <li>▲ Check rigidity of setup.</li> </ul>
<b>Shallow threads Problem with gauging</b> <ul style="list-style-type: none"> <li>▼ Insert not cresting.</li> <li>▼ Incorrect effective diameter.</li> </ul>	<ul style="list-style-type: none"> <li>▲ Check machined diameters.</li> <li>▲ Excessive tool wear or chipped on nose see remedies above.</li> </ul>



## Schnittdaten

Materialien	Schnittgeschwindigkeit m/min.(Ft/min) Wendeplattensorte			Anzahl von Steigungen		
	PM25	KM15	TIN25	P mm	TPI	Anzahl von Steigungen
Stahl mit niedrigem und mittlerem Kohlenstoffgehalt	120-80 (390-260)		250-210 (820-690)	0,50	48,0	4 - 6
				0,75	32,0	4 - 7
				1,00	24,0	4 - 8
				1,25	20,0	5 - 9
				1,50	16,0	6 - 10
Stahl mit hohem Kohlenstoffgehalt	110-70 (360-230)		210-150 (690-490)	1,75	14,0	7 - 12
				2,00	12,0	7 - 12
				2,50	10,0	8 - 14
				3,00	8,0	10 - 18
				3,50	7,0	11 - 18
Legierter Werkzeugstahl und Vergütungsstähle	100-70 (360-230)		180-140 (590-460)	4,00	6,0	11 - 18
				4,50	5,5	11 - 19
				5,00	5,0	12 - 20
				5,50	4,5	12 - 20
				6,00	4,0	12 - 20
Rostfreie Stähle	100-70 (360-230)	90-70 (295-230)	140-110 (460-360)	8,00	3,0	15 - 24
Guß HB 180-250		90-70 (295-230)				
Nichteisenmetalle		180-120 (590-390)				

### Allgemeine Empfehlungen:

- Die Gewindedreh-Geschwindigkeiten sollten normalerweise minimum 80 bis 90% der Drehgeschwindigkeiten haben, die zur Bearbeitung derselben Teile verwendet werden (wenn die Sorten kompatibel sind).
- Bevor man beginnt, sollte man den Spiralwinkel und die Anzahl der auf den Tabellen gezeigten Steigungen kontrollieren.
- Kontrollieren, daß die Spitzenhöhe stimmt.
- Falls es ein Problem gibt, bitte folgende Empfehlungen beachten und nur eine Variable auf einmal ändern. Das hilft, Probleme zu lösen.
- Keine Flankenzustellung bei Materialien, die bei der Bearbeitung härter werden.

## Problemen mit dem Werkstück

Problem	Ursache/Maßnahme
<b>Steigungsfehler (bei CNC-Maschinen)</b> ▼ Man hat zu nah am Werkstück angefangen. ▼ Die Geschwindigkeit in Richtung auf den Antritt ist zu hoch.	▲ Zyklus weiter von dem Werkstück entfernt anfangen. ▲ Geschwindigkeit um 10% reduzieren, bis sie korrekt ist.
<b>Gewinde, die nur auf einer Seite gebrochen sind</b> ▼ Nicht korrekter Steigungswinkel im Werkzeug.	▲ Steigungstabelle kontrollieren. ▲ Nochmal montieren aber mit der richtigen Unterlegplatte. ▲ Spitzenhöhe kontrollieren.
<b>Gewinde, die auf beide Seiten gebrochen sind</b> ▼ Zu langsame Bearbeitung. ▼ Schneidenaufbau.	▲ Oberflächen-Geschwindigkeit erhöhen. ▲ Spitzenhöhe kontrollieren. ▲ Eine beschichtete Sorte verwenden. ▲ Gewindedreh-Geschwindigkeit mit Drehgeschwindigkeit vergleichen.
<b>Lange und gefährliche Späne</b> ▼ Nicht korrekte Spanbrecher-Geometrie. ▼ Nicht korrekte Zustellungsmethode.	▲ Canela TD-Spanbrecher verwenden. ▲ Eine andere Zustellungsmethode verwenden.
<b>Vibrationsmarken auf beiden Flanken</b> ▼ Geringe Stabilität. ▼ Zu große Auskrägung.	▲ Unterlegplatte wechseln, um die Wendeschneidplatte zu verstärken. ▲ Klemmung des Werkzeuges kontrollieren. ▲ Die Auskrägung reduzieren. ▲ Die Stabilität des Aufbaues kontrollieren.
<b>Ungenauere Gewinde / Probleme mit den Abmessungen</b> ▼ Die Wendeschneidplatte macht eine schlechte Oberflächengüte. ▼ Nicht korrekter effektiver Durchmesser.	▲ Den bearbeiteten Durchmesser kontrollieren. ▲ Bei zuviel Verschleiß oder Ansammlung von Spänen in der Spitze, siehe obengenannte Maßnahmen.

**Helix chart**

**Feed direction towards the chuck**

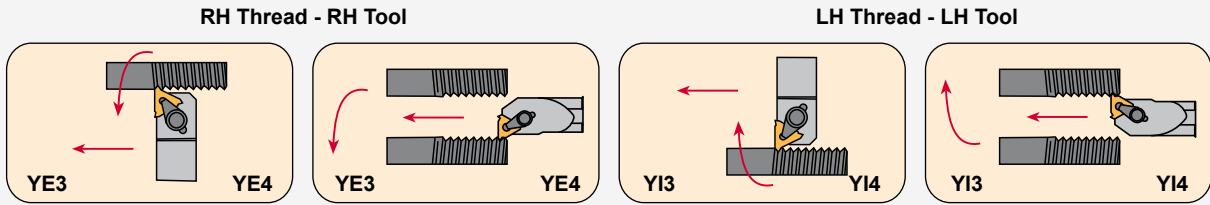

**Anvil to give correct helix**

Insert size	+3°	+2°	+1°	0°
16R	3424+3	3424+2	3424+1	YE3
16L	3425+3	3425+2	3425+1	YI3
22R	3430+3	3430+2	3430+1	YE4
22L	3431+3	3431+2	3431+1	YI4

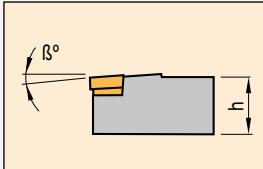
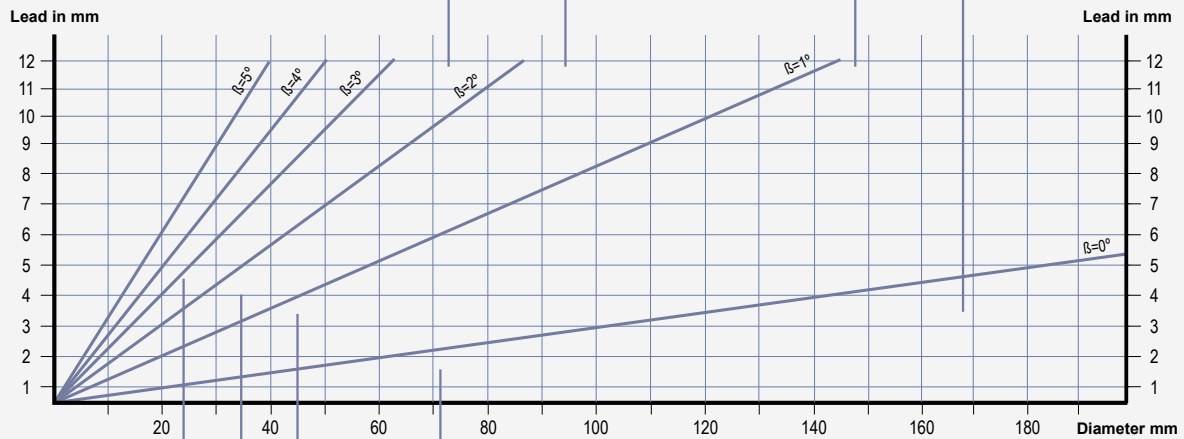

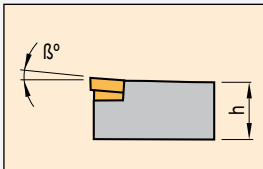

**Anvil to give correct helix**

Insert size	-3°	-2°	-1°	0°
16R	3424-3	3424-2	3424-1	YE3
16L	3425-3	3425-2	3425-1	YI3
22R	3430-3	3430-2	3430-1	YE4
22L	3431-3	3431-2	3431-1	YI4

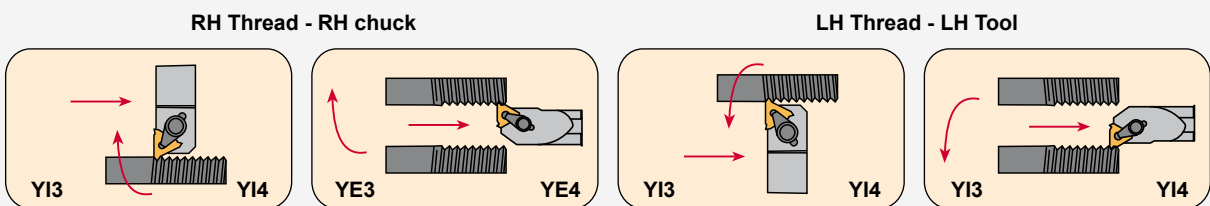

**Feed direction away from the chuck**



**Steigungs-Tabelle**

**Vorschubrichtung in Richtung Antrieb**

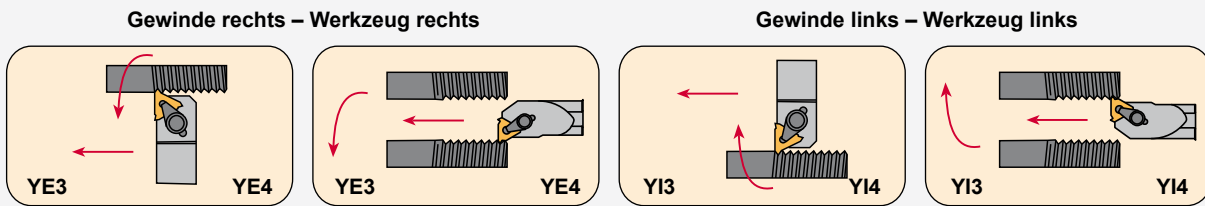

Nötige Unterlegplatte, um die korrekte Steigung zu erzeugen

Wendeplattengröße	+3°	+2°	+1°	0°
16R	3424+3	3424+2	3424+1	YE3
16L	3425+3	3425+2	3425+1	YI3
22R	3430+3	3430+2	3430+1	YE4
22L	3431+3	3431+2	3431+1	YI4

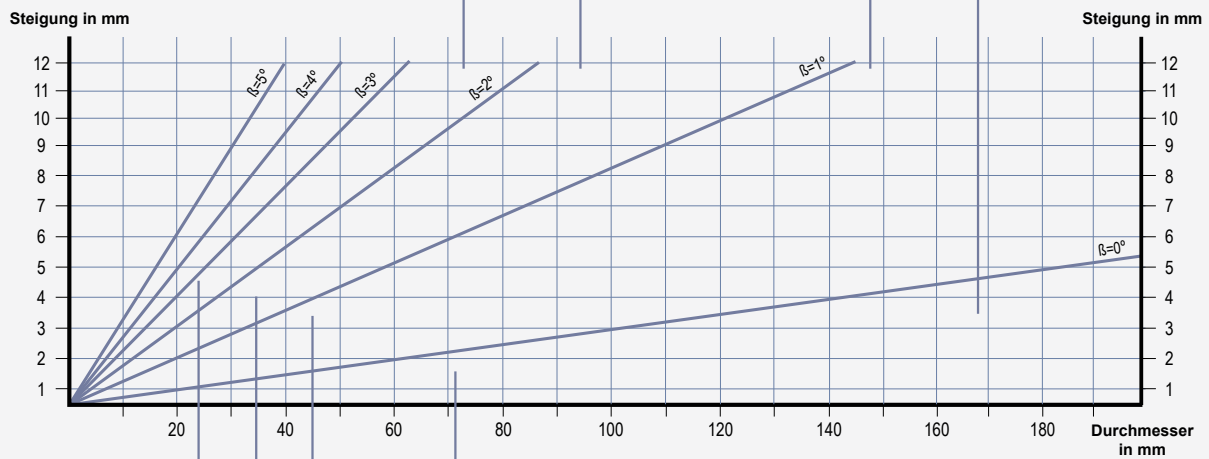
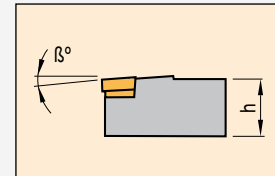

Nötige Unterlegplatte, um die korrekte Steigung zu erzeugen

Wendeplattengröße	-3°	-2°	-1°	0°
16R	3424-3	3424-2	3424-1	YE3
16L	3425-3	3425-2	3425-1	YI3
22R	3430-3	3430-2	3430-1	YE4
22L	3431-3	3431-2	3431-1	YI4

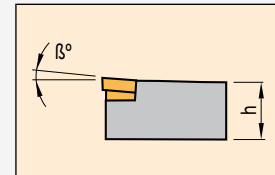

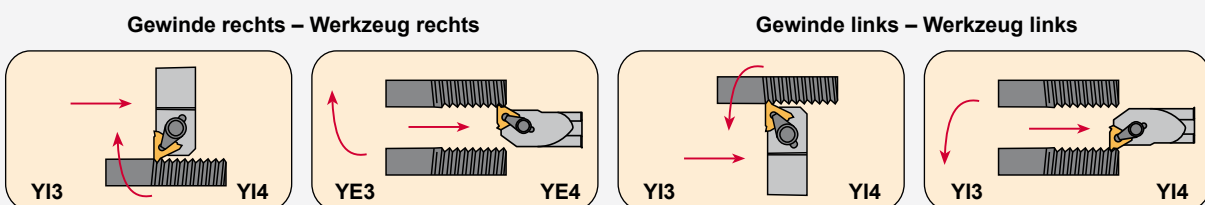

**Vorschubrichtung ab dem Antrieb**





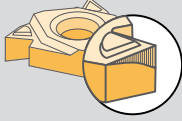
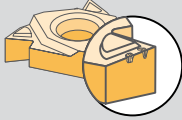
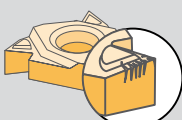
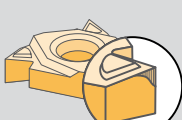

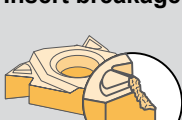
## Threading insert wear and tool life

	Problem	Remedy
<p><b>Rapid flank wear</b></p> 	<ul style="list-style-type: none"> <li>▼ Cutting speed too high.</li> <li>▼ Lack of coolant.</li> <li>▼ Infeed per pass too small - too many passes.</li> <li>▼ Incorrect grade.</li> </ul>	<ul style="list-style-type: none"> <li>▲ Reduce the cutting speed.</li> <li>▲ Increase the coolant supply.</li> <li>▲ Increase the depth of infeed for the smallest infeed depths - reduce the number of passes.</li> <li>▲ Select a more wear resistant grade.</li> </ul>
<p><b>Edge frittering</b></p> 	<ul style="list-style-type: none"> <li>▼ Instability of workholding and/or tool set-up.</li> </ul>	<ul style="list-style-type: none"> <li>▲ Check rigidity of operation.</li> <li>▲ Select a tougher grade.</li> </ul>
<p><b>Edge spalling</b></p> 	<ul style="list-style-type: none"> <li>▼ Intermittent coolant supply.</li> </ul>	<ul style="list-style-type: none"> <li>▲ Position coolant flow and/or increase coolant supply.</li> </ul>
<p><b>Uneven flank wear</b></p> 	<ul style="list-style-type: none"> <li>▼ Incorrect method of infeed.</li> <li>▼ Incorrect angle of inclination.</li> </ul>	<ul style="list-style-type: none"> <li>▲ In case of flank infeed use modified flank infeed. Decrease infeed angle 3-5°.</li> <li>▲ Correct the angle on inclination according to the diagram.</li> </ul>
<p><b>Excessive plastic deformation</b></p> 	<ul style="list-style-type: none"> <li>▼ Infeed per pass too big - too few passes.</li> <li>▼ Lack of coolant.</li> <li>▼ Cutting speed too high.</li> <li>▼ Incorrect grade.</li> <li>▼ Excessive stock removal from crest.</li> </ul>	<ul style="list-style-type: none"> <li>▲ Decrease the depth of infeed for the biggest depths. - Increase the number of passes.</li> <li>▲ Increase coolant supply.</li> <li>▲ Reduce the cutting speed.</li> <li>▲ Select a harder grade.</li> <li>▲ Check the volume of the material above the crest.</li> </ul>
<p><b>Insert breakage</b></p> 	<ul style="list-style-type: none"> <li>▼ Instability.</li> <li>▼ Lack of chip control.</li> <li>▼ Excessive plastic deformation.</li> <li>▼ Intermittent or inadequate coolant supply.</li> <li>▼ Incorrect preparation of the operation.</li> </ul>	<ul style="list-style-type: none"> <li>▲ Check rigidity of operation.</li> <li>▲ Select a tougher grade. Select modified flank infeed.</li> <li>▲ Machine with same infeed per pass.</li> <li>▲ Direct coolant flow and/or increase coolant supply.</li> <li>▲ Check dimension of blank.</li> </ul>
<p><b>Shallow thread profile</b></p>	<ul style="list-style-type: none"> <li>▼ Wrong centre height.</li> <li>▼ Insert not cresting.</li> <li>▼ Excessive tool wear.</li> </ul>	<ul style="list-style-type: none"> <li>▲ Adjust cutting edge height.</li> <li>▲ Check dimension of blank.</li> <li>▲ Change insert earlier.</li> </ul>
<p><b>Incorrect thread profile</b></p>	<ul style="list-style-type: none"> <li>▼ Incorrect tool setting.</li> </ul>	<ul style="list-style-type: none"> <li>▲ Correct tool setting.</li> </ul>
<p><b>Lack of chip control</b></p>	<ul style="list-style-type: none"> <li>▼ Incorrect depth of infeed per pass.</li> <li>▼ Radial infeed.</li> </ul>	<ul style="list-style-type: none"> <li>▲ For modified flank infeed use 3-5°.</li> <li>▲ Use geometry with modified flank infeed 1°.</li> </ul>
<p><b>Bad surface finish</b></p>	<ul style="list-style-type: none"> <li>▼ Cutting speed too low.</li> <li>▼ Incorrect angle of inclination.</li> <li>▼ Flank infeed.</li> </ul>	<ul style="list-style-type: none"> <li>▲ Increase the cutting speed.</li> <li>▲ Correct the angle of inclination according to diagram.</li> <li>▲ Use modified flank infeed or radial infeed.</li> </ul>

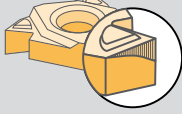
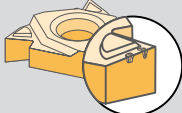
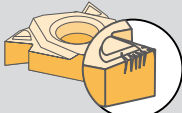
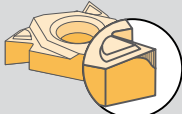

## Verschleiß und Standzeit der Wendeplatte zum Gewindedrehen

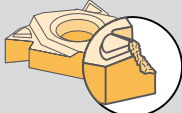
	Problem	Ursache und Maßnahmen
<p><b>Schneller Freiflächenverschleiß</b></p> 	<ul style="list-style-type: none"> <li>▼ Zu hohe Schnittgeschwindigkeit.</li> <li>▼ Mangel an Kühlmittel.</li> <li>▼ Zustellungstiefe pro Durchgang zu niedrig – zu viele Durchgänge.</li> <li>▼ Nicht korrekte Plattensorte.</li> </ul>	<ul style="list-style-type: none"> <li>▲ Schnittgeschwindigkeit reduzieren.</li> <li>▲ Kühlmittelzufuhr erhöhen.</li> <li>▲ Für kleine Zustellungen, die Zustellungstiefe erhöhen – Anzahl der Durchgänge reduzieren.</li> <li>▲ Eine Sorte mit höherem Widerstand gegen Verschleißfestigkeit wählen.</li> </ul>
<p><b>Absplittern der Schneidkante</b></p> 	<ul style="list-style-type: none"> <li>▼ Instabilität des Werkstückes und/oder des Werkzeuges</li> </ul>	<ul style="list-style-type: none"> <li>▲ Stabilität der Operation kontrollieren.</li> <li>▲ Eine härtere Sorte wählen.</li> </ul>
<p><b>Kammerisse</b></p> 	<ul style="list-style-type: none"> <li>▼ Unterbrochene Kühlmittelzufuhr.</li> </ul>	<ul style="list-style-type: none"> <li>▲ Kühlmittel kontrollieren und/oder Zufuhr erhöhen.</li> </ul>
<p><b>Ungleichmäßiger Freiflächenverschleiß</b></p> 	<ul style="list-style-type: none"> <li>▼ Falsche Methode der Flankenzustellung.</li> <li>▼ Falscher Neigungswinkel der Wendeplatte.</li> </ul>	<ul style="list-style-type: none"> <li>▲ Zustellmethode ändern. Zustellwinkel 3-5° vermindern.</li> <li>▲ Neigungswinkel gemäß Diagramm ändern.</li> </ul>
<p><b>Übermäßige plastische Verformung</b></p> 	<ul style="list-style-type: none"> <li>▼ Zustellungstiefe pro Durchgang zu groß – zu wenige Durchgänge.</li> <li>▼ Mangel an Kühlmittel.</li> <li>▼ Zu hohe Schnittgeschwindigkeit.</li> <li>▼ Nicht korrekte Plattensorte.</li> <li>▼ Zuviel Materialabnahme an der Wendeplattenspitze.</li> </ul>	<ul style="list-style-type: none"> <li>▲ Zustellungstiefe reduzieren - Anzahl der Durchgänge erhöhen.</li> <li>▲ Kühlmittelzufuhr erhöhen.</li> <li>▲ Schnittgeschwindigkeit reduzieren.</li> <li>▲ Eine härtere Sorte wählen.</li> <li>▲ Materialmenge an der Wendeplattenspitze kontrollieren.</li> </ul>
<p><b>Plattenbruch</b></p> 	<ul style="list-style-type: none"> <li>▼ Instabilität.</li> <li>▼ Unkontrollierte Späne.</li> <li>▼ Übermäßige plastische Verformung.</li> <li>▼ Unterbrochene oder ungeeignete Kühlmittelzufuhr.</li> <li>▼ Falsche Vorbereitung des Vorgangs.</li> </ul>	<ul style="list-style-type: none"> <li>▲ Stabilität der Operation kontrollieren.</li> <li>▲ Eine härtere Sorte wählen. Modifizierte Flankenzustellung wählen.</li> <li>▲ Mit derselben Zustellung per Steigung bearbeiten.</li> <li>▲ Kühlmittelzufuhr kontrollieren und/oder Zufuhr erhöhen.</li> <li>▲ Die Abmessung der Wendeplatte kontrollieren.</li> </ul>
<p><b>Zu kleines Gewindeprofil</b></p>	<ul style="list-style-type: none"> <li>▼ Falsche Spitzenhöhe.</li> <li>▼ Plattenbruch.</li> <li>▼ Übermäßiger Verschleiß.</li> </ul>	<ul style="list-style-type: none"> <li>▲ Schneidkantenhöhe einstellen.</li> <li>▲ Die Abmessung der Wendeplatte kontrollieren.</li> <li>▲ Wendeplatte früher wechseln.</li> </ul>
<p><b>Mangelhaftes Gewindeprofil</b></p>	<ul style="list-style-type: none"> <li>▼ Falsche Werkzeug/Wendeplattenkombination.</li> </ul>	<ul style="list-style-type: none"> <li>▲ Richtige Werkzeug/Wendeplattenkombination wählen.</li> </ul>
<p><b>Schlechte Spankontrolle</b></p>	<ul style="list-style-type: none"> <li>▼ Falsche Tiefe der Zustellung per Steigung.</li> <li>▼ Radiale Zustellung.</li> </ul>	<ul style="list-style-type: none"> <li>▲ Modifizierte Flankenzustellung von 3-5° verwenden.</li> <li>▲ Geometrien mit modifizierter Flankenzustellung von 1° wählen.</li> </ul>
<p><b>Schlechte Oberflächengüte</b></p>	<ul style="list-style-type: none"> <li>▼ Zu niedrige Schnittgeschwindigkeit.</li> <li>▼ Nicht korrekter Neigungswinkel.</li> <li>▼ Flankenzustellung.</li> </ul>	<ul style="list-style-type: none"> <li>▲ Schnittgeschwindigkeit erhöhen.</li> <li>▲ Neigungswinkel gemäß Diagramm korrigieren.</li> <li>▲ Modifizierte Flankenzustellung oder radiale Zustellung verwenden.</li> </ul>