

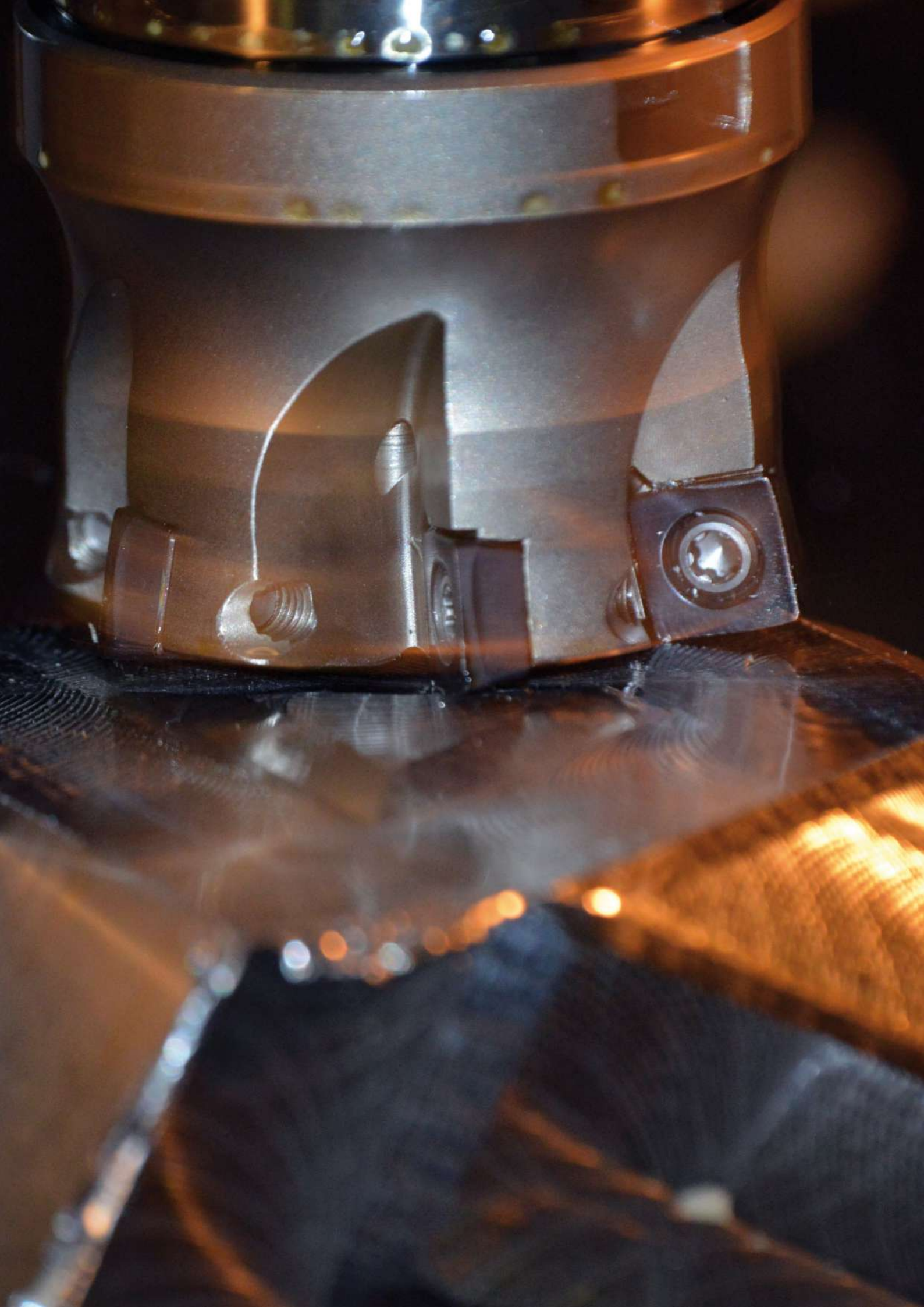



PROFILE MILLING CUTTERS PROFILFRÄSEN

Applications index Anwendungen	F119
High feed Hoher Vorschub	F120-127
Round inserts Fräser mit runden Wendeschneidplatten	F128-135
Aluminium die cutting Fräser für Aluminium-Formen	F136-138
Finishing ball nose Kugelbahnfräser zum Schlichten	F139-146





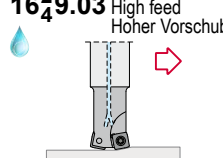
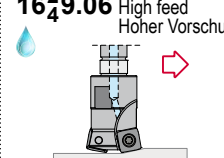

High feed Hoher Vorschub

<p>1629.03 High feed Hoher Vorschub</p>  <p>SPMX 0735.. SPMX 0945.. SPMX 1155..</p> <p>Page Seite F120</p>	<p>1629.06 High feed Hoher Vorschub</p>  <p>SPMX 0735.. SPMX 0945.. SPMX 1155..</p> <p>Page Seite F121</p>	<p>1639.93 High feed Hoher Vorschub</p>  <p>SPMX 0945..</p> <p>Page Seite F122</p>	<p>1649.93 High feed Hoher Vorschub</p>  <p>SPMX 1155..</p> <p>Page Seite F123</p>	
--	--	--	---	--

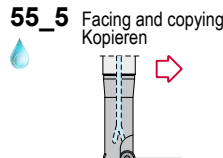
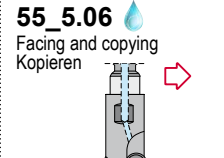
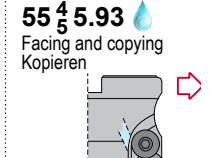
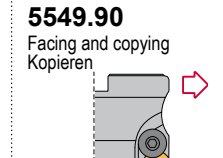



Round inserts Runde Wendeschneidplatten

<p>55_5 Facing and copying Kopieren</p>  <p>RD.. 0702.. RD.. 1604..</p> <p>Page Seite F128</p>	<p>55_5.06</p> <p>Facing and copying Kopieren</p>  <p>RD.. 0702.. RD.. 1604..</p> <p>Page Seite F129</p>	<p>55_5.93</p> <p>Facing and copying Kopieren</p>  <p>RD.. 12T3.. RD.. 1604..</p> <p>Page Seite F130</p>	<p>5549.90</p> <p>Facing and copying Kopieren</p>  <p>RPM.. 1204..</p> <p>Page Seite F131</p>	
--	--	--	--	--

Aluminium die cutting Fräser für Aluminium-Formen

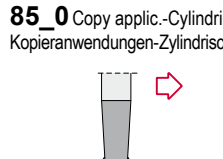
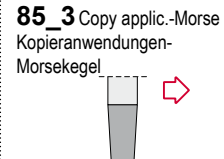
<p>0344.06</p> <p>General application Allgemeine Anwendungen</p>  <p>VCGT 1103.. VCGT 2205..</p> <p>Page Seite F136</p>	<p>0344.90</p> <p>General application Allgemeine Anwendungen</p>  <p>VCGT 2205..</p> <p>Page Seite F137</p>
---	---

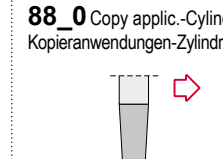
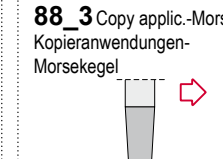
Finishing ball nose Kugelbahnfräser zum Schlichten

<p>85_0 Copy applic.-Cylindric Kopieranwendungen-Zylindrisch</p>  <p>HPR 10 HPR 32</p> <p>Page Seite F139</p>	<p>85_3 Copy applic.-Morse Kopieranwendungen-Morsekegel</p>  <p>HPR 25 HPR 32</p> <p>Page Seite F140</p>	<p>85_06 Copy applications Kopieranwendungen-Modular</p>  <p>HPR 10 HPR 25</p> <p>Page Seite F141</p>	<p>88_0 Copy applic.-Cylindric Kopieranwendungen-Zylindrisch</p>  <p>RPR 10 RPR 32</p> <p>Page Seite F142</p>	<p>88_3 Copy applic.-Morse Kopieranwendungen-Morsekegel</p>  <p>RPR 20 RPR 32</p> <p>Page Seite F143</p>
<p>88_06 Copy applications Kopieranwendungen-Modular</p>  <p>RPR 10 RPR 25</p> <p>Page Seite F144</p>				





Characteristics:
High feed square insert cutter for peripheral milling, ramp milling and drilling, pocket milling and copy milling.
It can be used in only one pass (roughing and finishing) and it is recommended for machining centers.

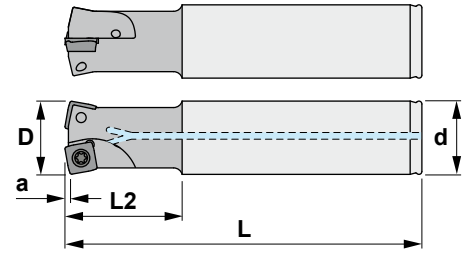

Eigenschaften:
Hoher Vorschubfräser mit vierkantigen Wendeschneidplatten zum Zirkularfräsen (Bohrlocherweiterung), Stufenfräsen, Bohren, Taschenfräsen und Kopierfräsen.
Für allgemeine Bearbeitungen mit nur einem Durchgang (Schruppen und Schlichten).
Empfohlen für Bearbeitungszentren.

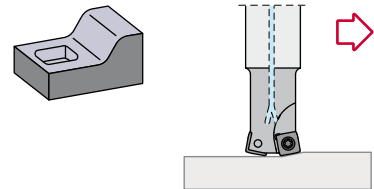

16²₄9.03

Reference Bezeichnung		D	L	L2	d	a	Insert size Wendeschneidplatte	
1629.03.016	2	16	110	20	16	0,6	SPMX 0735..	0,250
1629.03.020	3	20	130	30	20	0,9	SPMX 0735..	0,300
1629.03.025	4	25	140	40	25	0,9	SPMX 0735..	0,440
1629.03.032	5	32	150	50	32	0,9	SPMX 0735..	0,780
1639.03.025	2	25	140	40	25	1,4	SPMX 0945..	0,440
1639.03.032	4	32	150	50	32	1,4	SPMX 0945..	0,780
1639.03.035	4	35	150	50	32	1,4	SPMX 0945..	0,830
1649.03.032	3	32	150	50	32	1,8	SPMX 1155..	0,760

Reference Bezeichnung			Nm
1629.03.016	1430-IP	5510-IP	2.5
1629.03.020	1430-IP	5510-IP	2.5
1629.03.025	1430-IP	5510-IP	2.5
1629.03.032	1430-IP	5510-IP	2.5
1639.03.025	1440-IP	5515-IP	3.5
1639.03.032	1440-IP	5515-IP	3.5
1639.03.035	1440-IP	5515-IP	3.5
1649.03.032	1240-IP	5515-IP	3.5

SPMX

High feed.
Hoher Vorschub. F20

Reference / Bez.	l	s	d
SPMX 0735..	7,00	3,50	7,00
SPMX 0945..	9,70	4,40	9,70
SPMX 1155..	11,60	5,40	11,60

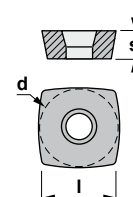



Characteristics:

High feed square insert cutter for peripheral milling, ramp milling and drilling, pocket milling and copy milling.

It can be used in only one pass (roughing and finishing) and it is recommended for machining centers.

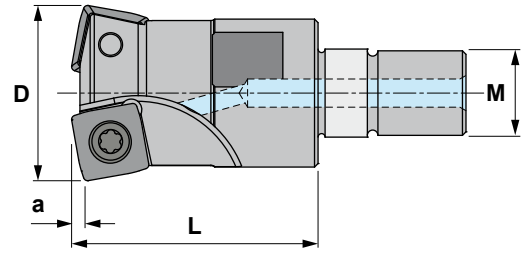

Eigenschaften:

Hoher Vorschubfräser mit vierkantigen Wendeschneidplatten zum Zirkularfräsen (Bohrlocherweiterung), Stufenfräsen, Bohren, Taschenfräsen und Kopierfräsen. Für allgemeine Bearbeitungen mit nur einem Durchgang (Schruppen und Schlichten).

Empfohlen für Bearbeitungszentren.

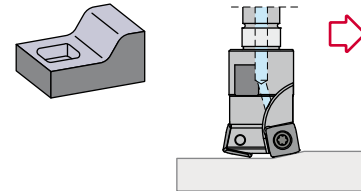

16²₄9.06

Reference Bezeichnung		D	L	M	a	Insert size Wendeschneidplatte	
1629.06.016	2	16	23	M8	0,6	SPMX 0735..	0,040
1629.06.020	3	20	30	M10	0,9	SPMX 0735..	0,050
1629.06.025	4	25	35	M12	0,9	SPMX 0735..	0,080
1629.06.032	5	32	43	M16	0,9	SPMX 0735..	0,180
1639.06.025	2	25	35	M12	1,4	SPMX 0945..	0,080
1639.06.032	4	32	43	M16	1,4	SPMX 0945..	0,180
1639.06.035	4	35	43	M16	1,4	SPMX 0945..	0,200
1639.06.042	5	42	43	M16	1,4	SPMX 0945..	0,240
1649.06.032	3	32	43	M16	1,8	SPMX 1155..	0,170
1649.06.035	3	35	43	M16	1,8	SPMX 1155..	0,180

Reference Bezeichnung			Nm
1629.06.016	1430-IP	5510-IP	2.5
1629.06.020	1430-IP	5510-IP	2.5
1629.06.025	1430-IP	5510-IP	2.5
1629.06.032	1430-IP	5510-IP	2.5
1639.06.025	1440-IP	5515-IP	3.5
1639.06.032	1440-IP	5515-IP	3.5
1639.06.035	1440-IP	5515-IP	3.5
1639.06.042	1440-IP	5515-IP	3.5
1649.06.032	1240-IP	5515-IP	3.5
1649.06.035	1240-IP	5515-IP	3.5

SPMX

High feed.
Hoher Vorschub. F20

Reference / Bez.	l	s	d
SPMX 0735..	7,00	3,50	7,00
SPMX 0945..	9,70	4,40	9,70
SPMX 1155..	11,60	5,40	11,60

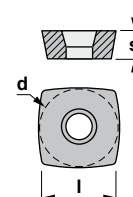



Characteristics:

High feed square insert cutter for peripheral milling, ramp milling and drilling, pocket milling and copy milling.

It can be used in only one pass (roughing and finishing) and it is recommended for machining centers.

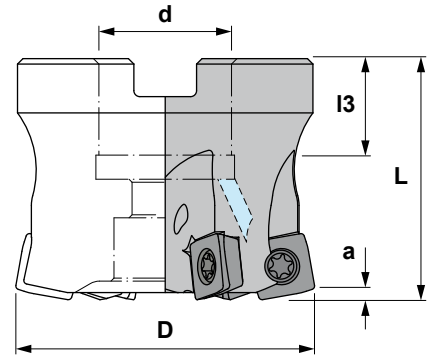

Eigenschaften:

Hoher Vorschubfräser mit vierkantigen Wendeschneidplatten zum Zirkularfräsen (Bohrlocherweiterung), Stufenfräsen, Bohren, Taschenfräsen und Kopierfräsen.

Für allgemeine Bearbeitungen mit nur einem Durchgang (Schruppen und Schlichten). Empfohlen für Bearbeitungszentren.

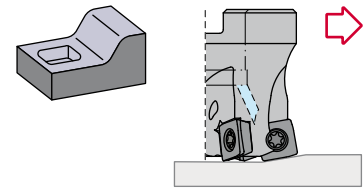

1639.93

Reference Bezeichnung		D	L	d	l3	a	Insert size Wendeschneidplatte	
1639.93.040	5	40	40	16	18	1,4	SPMX 0945..	0,190
1639.93.042	5	42	40	16	18	1,4	SPMX 0945..	0,210
1639.93.050	6	50	40	22	20	1,4	SPMX 0945..	0,320
1639.93.052	7	52	40	22	20	1,4	SPMX 0945..	0,340
1639.93.066	8	66	50	27	22	1,4	SPMX 0945..	0,780

Reference Bezeichnung				Nm
1639.93.040	1440-IP	5515-IP	1058	3.5
1639.93.042	1440-IP	5515-IP	1058	3.5
1639.93.050	1440-IP	5515-IP	912,10	3.5
1639.93.052	1440-IP	5515-IP	912,10	3.5
1639.93.066	1440-IP	5515-IP	912,12	3.5

SPMX

High feed. Hoher Vorschub. F20

Reference / Bez.	l	s	d
SPMX 0945..	9,70	4,40	9,70

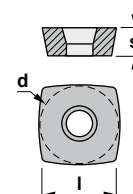

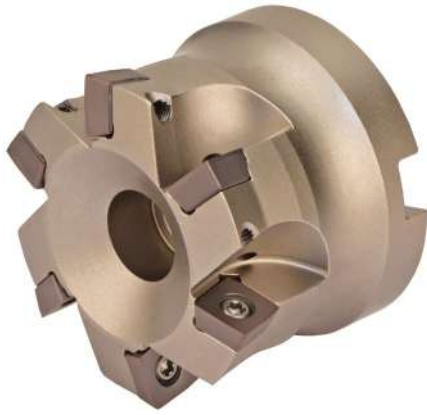

Characteristics:

High feed square insert cutter for peripheral milling, ramp milling and drilling, pocket milling and copy milling.

It can be used in only one pass (roughing and finishing) and it is recommended for machining centers.

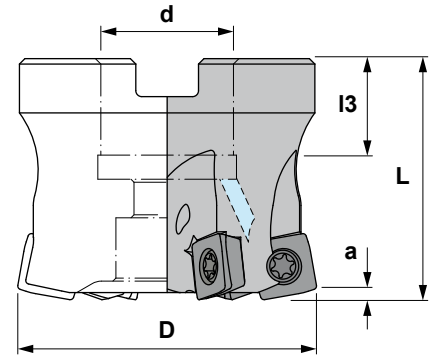

Eigenschaften:

Hoher Vorschubfräser mit vierkantigen Wendeschneidplatten zum Zirkularfräsen (Bohrlocherweiterung), Stufenfräsen, Bohren, Taschenfräsen und Kopierfräsen.

Für allgemeine Bearbeitungen mit nur einem Durchgang (Schruppen und Schlichten). Empfohlen für Bearbeitungszentren.

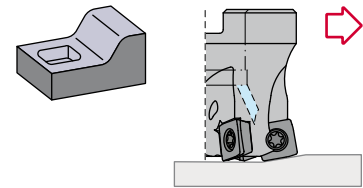

1649.93

Reference Bezeichnung		D	L	d	l3	a	Insert size Wendeschneidplatte	
1649.93.050	5	50	40	22	20	1,8	SPMX 1155..	0,290
1649.93.052	5	52	40	22	20	1,8	SPMX 1155..	0,310
1649.93.063	6	63	50	27	22	1,8	SPMX 1155..	0,720
1649.93.066	7	66	50	27	22	1,8	SPMX 1155..	0,740
1649.93.080	8	80	50	27	22	1,8	SPMX 1155..	0,980

Reference Bezeichnung				Nm
1649.93.050	1240-IP	5515-IP	912,10	3.5
1649.93.052	1240-IP	5515-IP	912,10	3.5
1649.93.063	1240-IP	5515-IP	912,12	3.5
1649.93.066	1240-IP	5515-IP	912,12	3.5
1649.93.080	1240-IP	5515-IP	912,12	3.5

SPMX

High feed. F20
Hoher Vorschub.

Reference / Bez.	l	s	d
SPMX 1155..	11,60	5,40	11,60

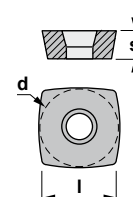

Recommended cutting conditions

Material	P	Hardness	Insert	Grade	Standard milling				High feed milling			
					Vc	fz	ap	ae	Vc	fz	ap	ae
Mild steel		<180HB	SPMX 073505	TL20	170 (120-220)	1,0	0,5/0,8	100%	200	1,0	0,4	100%
			SPMX 094506			1,2	0,5/1,0	100%		1,4	0,5	100%
			SPMX 115506			1,5	0,8/1,5	100%		1,4	0,8	100%
Carbon steel, alloyed steel		180-280HB	SPMX 073505	TL20	150 (100-200)	0,8	0,5/0,7	100%	200	1,0	0,4	100%
			SPMX 094506			1,0	0,5/0,7	100%		1,2	0,5	100%
			SPMX 115506			1,2	0,6/1,5	100%		1,2	0,8	100%
Carbon steel, alloyed steel		280-350HB	SPMX 073505	TL20	120 (80-150)	0,8	0,5/0,7	100%	180	1,0	0,3	100%
			SPMX 094506			1,0	0,5/0,7	100%		1,2	0,4	100%
			SPMX 115506			1,2	0,5/1,0	100%		1,2	0,6	100%
Alloyed tool steel		<350HB	SPMX 073505	TL20	120 (80-140)	0,8	0,5/0,7	100%	180	0,6	0,3	100%
			SPMX 094506			1,0	0,5/0,7	100%		0,8	0,4	100%
			SPMX 115506			1,0	0,5/1,0	100%		0,8	0,6	100%
Prehardened steel		35-45HRC	SPMX 073505	TL20	100 (70 (50-90))	0,6	0,4/0,6	100%	150	0,6	0,3	100%
			SPMX 094506			0,8	0,4/0,6	100%		0,8	0,4	100%
			SPMX 115506			0,8	0,4/0,8	100%		0,8	0,5	100%

Material	M	Hardness	Insert	Grade	Standard milling				High feed milling			
					Vc	fz	ap	ae	Vc	fz	ap	ae
Stainless steel		<200HB	SPMX 073505	TL20	100 (60-120)	0,4	0,5/0,7	100%	-	-	-	-
			SPMX 094506			0,4	0,5/1,0	100%		-	-	-
			SPMX 115506			0,4	0,6/1,5	100%		-	-	-
PH, Duplex		<200HB	SPMX 073505	TL20	70 (50-90)	0,4	0,3/0,5	100%	-	-	-	-
			SPMX 094506			0,4	0,3/0,5	100%		-	-	-
			SPMX 115506			0,4	0,4/0,8	100%		-	-	-

Material	K	Hardness	Insert	Grade	Standard milling				High feed milling			
					Vc	fz	ap	ae	Vc	fz	ap	ae
Grey cast iron		<200HB	SPMX 073505	TL20	150 (100-200)	1,0	0,5/0,7	100%	-	-	-	-
			SPMX 094506			1,2	0,5/0,8	100%		-	-	-
			SPMX 115506			1,2	0,6/1,5	100%		-	-	-
Ductile cast iron		<450MPa	SPMX 073505	TL20	120 (80-160)	1,0	0,4/0,6	100%	-	-	-	-
			SPMX 094506			1,0	0,4/0,6	100%		-	-	-
			SPMX 115506			1,0	0,5/0,8	100%		-	-	-

Material	H	Hardness	Insert	Grade	Standard milling				High feed milling			
					Vc	fz	ap	ae	Vc	fz	ap	ae
Hardened steel		40-55HRC	SPMX 073505	TL20	70 (50-90)	0,5	0,3/0,5	100%	120	0,6	0,3	100%
			SPMX 094506			0,6	0,3/0,5	100%		0,6	0,3	100%
			SPMX 115506			0,6	0,3/0,6	100%		0,6	0,4	100%

Configuration note

When using the milling cutter 1629, 1639 or 1649 it must be configured as a milling cutter with radius RE.
The approximate uncut portions cut of the configurations are the following:

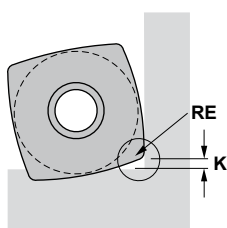

Insert size	RE	K mm
SPMX 073505	1,7	0,8
SPMX 094506	2,3	1,6
SPMX 115506	2,695	2,1

Ø16 max. Ap. 0,5

Empfohlene Schnittdaten

Materialien	P	Härte	WSP	Sorte	Standard-Fräsen				Fräsen mit hohem Vorschub			
					Vc	fz	ap	ae	Vc	fz	ap	ae
Baustahl		<180HB	SPMX 073505	TL20	170 (120-220)	1,0	0,5/0,8	100%	200	1,0	0,4	100%
			SPMX 094506			1,2	0,5/1,0	100%		1,4	0,5	100%
			SPMX 115506			1,5	0,8/1,5	100%		1,4	0,8	100%
Kohlenstoffstahl, legierter Stahl		180-280HB	SPMX 073505	TL20	150 (100-200)	0,8	0,5/0,7	100%	200	1,0	0,4	100%
			SPMX 094506			1,0	0,5/0,7	100%		1,2	0,5	100%
			SPMX 115506			1,2	0,6/1,5	100%		1,2	0,8	100%
Kohlenstoffstahl, legierter Stahl		280-350HB	SPMX 073505	TL20	120 (80-150)	0,8	0,5/0,7	100%	180	1,0	0,3	100%
			SPMX 094506			1,0	0,5/0,7	100%		1,2	0,4	100%
			SPMX 115506			1,2	0,5/1,0	100%		1,2	0,6	100%
Legierter Werkzeugstahl		<350HB	SPMX 073505	TL20	120 (80-140)	0,8	0,5/0,7	100%	180	0,6	0,3	100%
			SPMX 094506			1,0	0,5/0,7	100%		0,8	0,4	100%
			SPMX 115506			1,0	0,5/1,0	100%		0,8	0,6	100%
Vorgehärteter Stahl		35-45HRC	SPMX 073505	TL20	100 (70 (50-90))	0,6	0,4/0,6	100%	150	0,6	0,3	100%
			SPMX 094506			0,8	0,4/0,6	100%		0,8	0,4	100%
			SPMX 115506			0,8	0,4/0,8	100%		0,8	0,5	100%

Materialien	M	Härte	WSP	Sorte	Standard-Fräsen				Fräsen mit hohem Vorschub			
					Vc	fz	ap	ae	Vc	fz	ap	ae
Rostfreier Stahl		<200HB	SPMX 073505	TL20	100 (60-120)	0,4	0,5/0,7	100%	-	-	-	-
			SPMX 094506			0,4	0,5/1,0	100%		-	-	-
			SPMX 115506			0,4	0,6/1,5	100%		-	-	-
PH, Duplex		<200HB	SPMX 073505	TL20	70 (50-90)	0,4	0,3/0,5	100%	-	-	-	-
			SPMX 094506			0,4	0,3/0,5	100%		-	-	-
			SPMX 115506			0,4	0,4/0,8	100%		-	-	-

Materialien	K	Härte	WSP	Sorte	Standard-Fräsen				Fräsen mit hohem Vorschub			
					Vc	fz	ap	ae	Vc	fz	ap	ae
Grauguß		<200HB	SPMX 073505	TL20	150 (100-200)	1,0	0,5/0,7	100%	-	-	-	-
			SPMX 094506			1,2	0,5/0,8	100%		-	-	-
			SPMX 115506			1,2	0,6/1,5	100%		-	-	-
Duktiles Gußeisen		<450MPa	SPMX 073505	TL20	120 (80-160)	1,0	0,4/0,6	100%	-	-	-	-
			SPMX 094506			1,0	0,4/0,6	100%		-	-	-
			SPMX 115506			1,0	0,5/0,8	100%		-	-	-

Materialien	H	Härte	WSP	Sorte	Standard-Fräsen				Fräsen mit hohem Vorschub			
					Vc	fz	ap	ae	Vc	fz	ap	ae
Gehärteter Stahl		40-55HRC	SPMX 073505	TL20	70 (50-90)	0,5	0,3/0,5	100%	120	0,6	0,3	100%
			SPMX 094506			0,6	0,3/0,5	100%		0,6	0,3	100%
			SPMX 115506			0,6	0,3/0,6	100%		0,6	0,4	100%

Einstellungshinweis

Beim Einsatz des Fräasers 1629, 1639 oder 1649 empfehlen wir, den Fräser wie ein RE-Radiusfräser einzustellen.
Die ungefähre ungeschnittene Teile der Einstellung sind wie folgt:

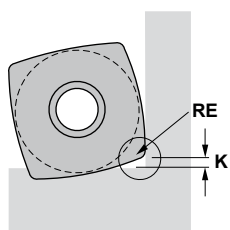

WSP-Größe	RE	K mm
SPMX 073505	1,7	0,8
SPMX 094506	2,3	1,6
SPMX 115506	2,695	2,1

Ø16 max. Ap. 0,5

Processing by direct milling is also possible

Since the cutting flute does not extend to the center, there are limitations on the ramp angle and hole diameter, but as shown below, processing by direct milling without a pilot hole is possible for ramping and helical milling.

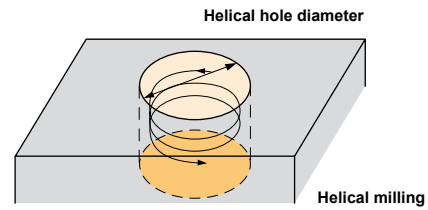
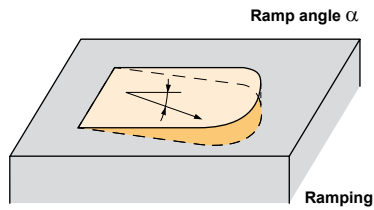

Insert size	SPMX 0735..			
Tool diameter	Ø16	Ø20	Ø25	Ø32
Maximum ramp angle α	2°	2°	2°	1°
Hole diameter	Ø21-30	Ø29-38	Ø39-48	Ø52-61

Insert size	SPMX 0945..							
Tool diameter	Ø25	Ø32	Ø35	Ø40	Ø42	Ø50	Ø52	Ø66
Maximum ramp angle α	2°	2°	2°	1°	1°	1°	1°	0,5°
Hole diameter	Ø36-48	Ø50-62	Ø56-68	Ø66-78	Ø70-82	Ø86-98	Ø90-102	Ø118-130

Insert size	SPMX 1155..						
Tool diameter	Ø32	Ø35	Ø50	Ø52	Ø63	Ø66	Ø80
Maximum ramp angle α	2°	2°	1°	1°	0,5°	0,5°	0,5°
Hole diameter	Ø47-62	Ø53-68	Ø83-98	Ø87-102	Ø109-124	Ø115-130	Ø143-158

Note

- The ramp angle α should be set within the ranges listed above. Use at ramp angles of 1° or less recommended.
- For hole diameters outside the ranges listed above, a pilot hole should be drilled before milling.

Verarbeitung durch das direkte Fräsen ist auch möglich

Da sich die Schneide bis zu das Zentrum nicht ausstreckt, gibt es Beschränkungen auf den Rampen-Winkel, und den Loch-Durchmesser. Aber zum Einwärtskopieren und zum Bohrzirkularfräsen, wie unten gezeigt, ist die Verarbeitung durch das direkte Fräsen ohne eine Vorbohrung möglich.

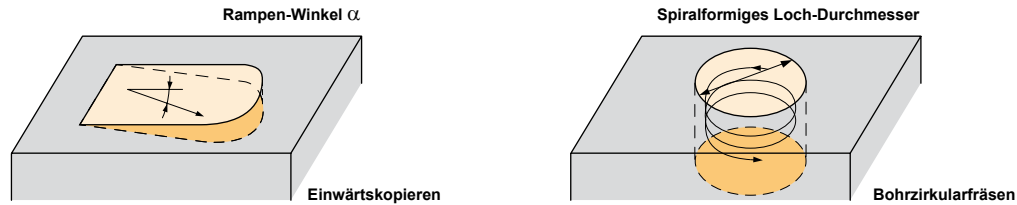

Wendeschneidplatte	SPMX 0735..			
Werkzeugdurchmesser	Ø16	Ø20	Ø25	Ø32
Maximaler Rampen-Winkel α	2°	2°	2°	1°
Lochdurchmesser	Ø21-30	Ø29-38	Ø39-48	Ø52-61

Wendeschneidplatte	SPMX 0945..							
Werkzeugdurchmesser	Ø25	Ø32	Ø35	Ø40	Ø42	Ø50	Ø52	Ø66
Maximaler Rampen-Winkel α	2°	2°	2°	1°	1°	1°	1°	0,5°
Lochdurchmesser	Ø36-48	Ø50-62	Ø56-68	Ø66-78	Ø70-82	Ø86-98	Ø90-102	Ø118-130

Wendeschneidplatte	SPMX 1155..						
Werkzeugdurchmesser	Ø32	Ø35	Ø50	Ø52	Ø63	Ø66	Ø80
Maximaler Rampen-Winkel α	2°	2°	1°	1°	0,5°	0,5°	0,5°
Lochdurchmesser	Ø47-62	Ø53-68	Ø83-98	Ø87-102	Ø109-124	Ø115-130	Ø143-158

Bemerkung

- Der Rampen-Winkel α sollte innerhalb der Auswahl gesetzt werden, die oben verzeichnet ist. Die Verwendung von Rampen-Winkeln von 1° oder weniger ist empfohlen.
- Für Loch-Diameter außerhalb der Auswahl, die oben verzeichnet ist, sollte ein Loch vor dem Fräsen gebohrt werden.



Characteristics:

Round insert end mill for slot milling, peripheral milling, ramp milling and drilling, pocket milling and copy milling.

It can be used in only one pass (roughing and finishing) and it is recommended for conventional milling machines and machining centers.

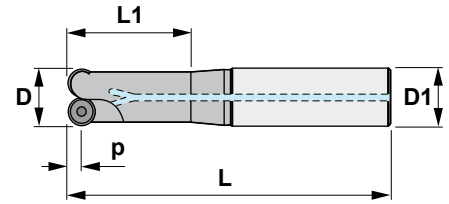



Eigenschaften:

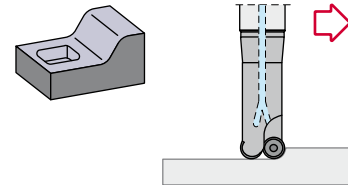

Fräser mit runden Wendeschneidplatten zum Zirkularfräsen (Bohrlocherweiterung), Stufenfräsen, Bohren, Taschenfräsen und Kopierfräsen.

Für allgemeine Bearbeitungen mit nur einem Durchgang (Schruppen und Schlichten). Empfohlen für konventionelle Fräsmaschinen und Bearbeitungszentren.



55_5 

Reference Bezeichnung		D	L	D1	L1	p	Insert size Wendeschneidplatte	
5525.00.015	2	15	100	20	40	3,5	RD.. 0702M0	0,180
5525.01.015	2	15	150	20	40	3,5	RD.. 0702M0	0,300
5525.00.016	2	16	100	20	40	3,5	RD.. 0702M0	0,185
5525.01.016	2	16	150	20	40	3,5	RD.. 0702M0	0,310
5535.00.020	2	20	100	20	40	5,0	RD.. 1003M0	0,220
5535.01.020	2	20	150	20	40	5,0	RD.. 1003M0	0,340
5545.00.025	2	25	125	25	50	6,0	RD.. 12T3M0	0,460
5545.01.025	2	25	180	25	60	6,0	RD.. 12T3M0	0,670
5545.00.032	3	32	125	32	50	6,0	RD.. 12T3M0	0,740
5545.01.032	3	32	180	32	60	6,0	RD.. 12T3M0	1,080
5555.01.032	2	32	180	32	60	8,0	RD.. 1604M0	1,080

Reference Bezeichnung			Nm
5525.00.015	1425	5507	0.9
5525.01.015	1425	5507	0.9
5525.00.016	1425	5507	0.9
5525.01.016	1425	5507	0.9
5535.00.020	1435	5515	3.0
5535.01.020	1435	5515	3.0
5545.00.025	1435	5515	3.0
5545.01.025	1435	5515	3.0
5545.00.032	1435	5515	3.0
5545.01.032	1435	5515	3.0
5555.01.032	1245	5515	3.0

RD.. Round positive inserts with 15° clearance.  F15-16
Runde positive Wendeschneidplatten mit 15° Freiwinkel.

Reference / Bez.	s	d
RD.. 0702M0	2,38	7,00
RD.. 1003M0	3,18	10,00
RD.. 12T3M0	3,97	12,00
RD.. 1604M0	4,76	16,00

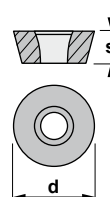



Characteristics:

Round insert end mill for slot milling, peripheral milling, ramp milling and drilling, pocket milling and copy milling.

It can be used in only one pass (roughing and finishing) and it is recommended for conventional milling machines and machining centers.

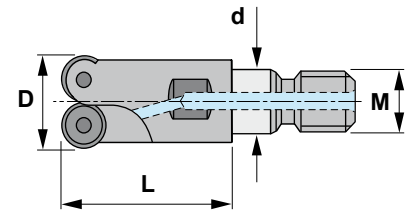

Eigenschaften:

Fräser mit runden Wendeschneidplatten zum Zirkularfräsen (Bohrlocherweiterung), Stufenfräsen, Bohren, Taschenfräsen und Kopierfräsen.

Für allgemeine Bearbeitungen mit nur einem Durchgang (Schruppen und Schlichten).
Empfohlen für konventionelle Fräsmaschinen und Bearbeitungszentren.

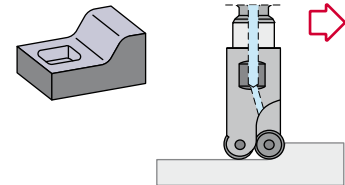

55_5.06

Reference Bezeichnung		D	L	M	d	Insert size Wendeschneidplatte	
5525.06.016	2	16	23	M8	14	RD.. 0702..	0,030
5535.06.020	2	20	30	M10	18	RD.. 1003..	0,060
5535.06.025	3	25	35	M12	21	RD.. 1003..	0,095
5535.06.035	4	35	43	M16	29	RD.. 1003..	0,225
5535.06.042	5	42	43	M16	29	RD.. 1003..	0,320
5545.06.025	2	25	43	M12	21	RD.. 12T3..	0,095
5545.06.032	3	32	43	M16	29	RD.. 12T3..	0,230
5545.06.035	3	35	43	M16	29	RD.. 12T3..	0,250
5545.06.042	4	42	43	M16	29	RD.. 12T3..	0,320
5545.06.042Z=5	5	42	43	M16	29	RD.. 12T3..	0,320
5555.06.032	2	32	43	M16	29	RD.. 1604..	0,250

Reference Bezeichnung			Nm
5525.06.016	1425	5507	0.9
5535.06.020	1435	5515	3.0
5535.06.025	1435	5515	3.0
5535.06.035	1435	5515	3.0
5535.06.042	1435	5515	3.0
5545.06.025	1435	5515	3.0
5545.06.032	1435	5515	3.0
5545.06.035	1435	5515	3.0
5545.06.042	1435	5515	3.0
5545.06.042Z=5	1435	5515	3.0
5555.06.032	1245	5515	3.0

RD.. Round positive inserts with 15° clearance. F15-16
Runde positive Wendeschneidplatten mit 15° Freiwinkel.

Reference / Bez.	s	d
RD.. 0702M0	2,38	7,00
RD.. 1003M0	3,18	10,00
RD.. 12T3M0	3,97	12,00
RD.. 1604M0	4,76	16,00

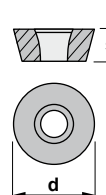



Characteristics:

Round insert cutter for slot milling, peripheral milling, ramp milling and drilling, pocket milling and copy milling.

It can be used in only one pass (roughing and finishing) and it is recommended for conventional milling machines and machining centers.

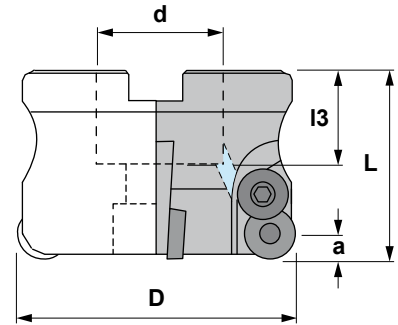

Eigenschaften:

Fräser mit runden Wendeschneidplatten zum Zirkularfräsen (Bohrlocherweiterung), Stufenfräsen, Bohren, Taschenfräsen und Kopierfräsen.

Für allgemeine Bearbeitungen mit nur einem Durchgang (Schruppen und Schlichten).

Empfohlen für konventionelle Fräsmaschinen und Bearbeitungszentren.

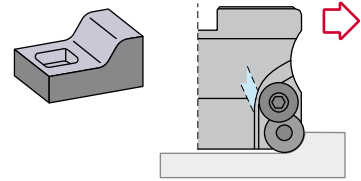

55⁴5.93

Reference Bezeichnung		D	L	d	l3	a	Insert size Wendeschneidplatte	
5545.93.052	5	52	50	22	20	6	RD.. 12T3..	0,450
5545.93.066	6	66	50	27	22	6	RD.. 12T3..	0,770
5545.93.080	7	80	50	27	22	6	RD.. 12T3..	1,200
5555.93.052	4	52	50	22	20	8	RD.. 1604..	0,350
5555.93.066	5	66	50	27	22	8	RD.. 1604..	0,700
5555.93.080	6	80	50	27	22	8	RD.. 1604..	1,050
5555.93.100	7	100	55	32	25	8	RD.. 1604..	1,800
5555.90.125	8	125	55	40	30	8	RD.. 1604..	3,500
5555.90.160	9	160	55	40	30	8	RD.. 1604..	5,600

Reference Bezeichnung					Nm	
5545.93.052	1235	2009	912,10	5515	-	3.0
5545.93.066	1235	2009	912,12	5515	-	3.0
5545.93.080	1235	2009	912,12	5515	-	3.0
5555.93.052	1245	2010	912,10	5515	-	3.0
5555.93.066	1245	2010	912,12	5515	-	3.0
5555.93.080	1245	2010	912,12	5515	-	3.0
5555.93.100	1245	2010	912,17	-	5615	3.0
5555.90.125	1245	2010	-	-	5615	3.0
5555.90.160	1245	2010	912,52	-	5615	3.0

RD.. Round positive inserts with 15° clearance. F15-16
Runde positive Wendeschneidplatten mit 15° Freiwinkel.

Reference / Bez.	s	d
RD.. 12T3M0	3,97	12,00
RD.. 1604M0	4,76	16,00

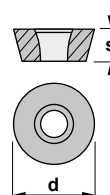

RDHW



RDMT



RDMW





Characteristics:

Round insert cutter for slot milling, peripheral milling, ramp milling and drilling, pocket milling and copy milling.

It can be used in only one pass (roughing and finishing) and it is recommended for conventional milling machines and machining centers.

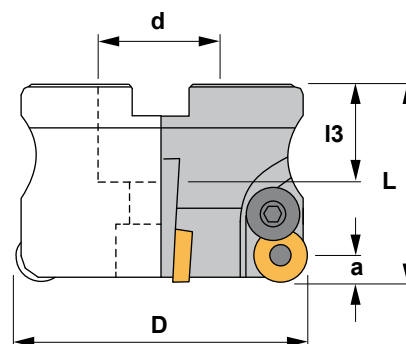

Eigenschaften:

Fräser mit runden Wendeschneidplatten zum Zirkularfräsen (Bohrlocherweiterung), Stufenfräsen, Bohren, Taschenfräsen und Kopierfräsen.

Für allgemeine Bearbeitungen mit nur einem Durchgang (Schruppen und Schlichten).
Empfohlen für konventionelle Fräsmaschinen und Bearbeitungszentren.

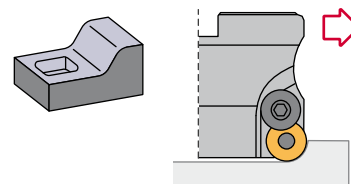

5549.90

Reference Bezeichnung		D	L	d	l3	a	Insert size Wendeschneidplatte	
5549.90.040	3	40	40	16	18	6	RPM.. 1204M0	0,200
5549.90.050	4	50	40	22	20	6	RPM.. 1204M0	0,300
5549.90.063	5	63	50	27	22	6	RPM.. 1204M0	0,650
5549.90.080	6	80	50	32	25	6	RPM.. 1204M0	1,150
5549.90.100	7	100	50	40	30	6	RPM.. 1204M0	1,750
5549.90.125	7	125	63	40	30	6	RPM.. 1204M0	3,100

Reference Bezeichnung							Nm
5549.90.040	1025	5003	1240	5515	-	1058	3.0
5549.90.050	1025	5003	1240	5515	-	912,10	3.0
5549.90.063	1025	5003	1240	5515	-	912,12	3.0
5549.90.080	1025	5003	1240	5515	-	912,17	3.0
5549.90.100	1025	5003	1240	-	5615	912,20	3.0
5549.90.125	1025	5003	1240	-	5615	-	3.0

RPM..

Round positive inserts with 11° clearance. Runde positive Wendeschneidplatten mit 11° Freiwinkel. F16

Reference / Bez.	s	d
RPM.. 1204M0	4,76	12,00

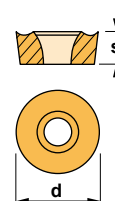

RPMT



RPMW



Material	Cutting speed Vc (m/min)	Per-flute feed rate fz (mm/tooth)	Ø12 - Ø20			Ø24 - Ø25			Ø32 - Ø35		
			Rotation speed min ⁻¹	Feed rate mm/min	Q value cm ³ /min	Rotation speed min ⁻¹	Feed rate mm/min	Q value cm ³ /min	Rotation speed min ⁻¹	Feed rate mm/min	Q value cm ³ /min
Mild steels (200 HB)	150-250	0,3-0,8	3980	3180	28,6	3180	2540	28,6	2490	2990	43,1
			Vc=250m/min fz=0,4mm/tooth ap=1,5mm ae=0,3D								
			3980	3180	47,7	3180	2540	47,6	2490	2990	71,8
Carbon steels Alloyed steels (30 HRC)	120-230	0,3-0,8	Vc=250m/min fz=0,4mm/tooth ap=1,5mm ae=0,5D								
			3180	2540	22,9	2550	2040	23	1990	2390	34,4
			3180	2540	38,1	2550	2040	38,3	1990	2390	57,4
Carbon steels Alloyed steels (30-40 HRC)	100-200	0,2-0,6	Vc=200m/min fz=0,4mm/tooth ap=1,5mm ae=0,3D								
			2390	960	8,6	1910	760	8,6	1490	890	12,8
			2390	1430	21,5	1910	1150	21,6	1490	1340	32,2
Carbon steels Alloyed steels (40-45 HRC)	60-150	0,15-0,3	Vc=150m/min fz=0,2mm/tooth ap=1,5mm ae=0,5D								
			1590	480	2,9	1270	380	2,9	990	450	4,3
			1590	640	6,4	1270	510	6,4	990	590	9,4
Carbon steels Alloyed steels (45-50 HRC)	60-100	0,15-0,3	Vc=100m/min fz=0,15mm/tooth ap=1mm ae=0,3D								
			1270	380	2,3	1020	310	2,3	800	360	3,5
			1270	380	3,8	1020	310	3,9	800	360	5,8
Alloyed steels (50-60 HRC)	50-100	0,05-0,2	Vc=80m/min fz=0,15mm/tooth ap=1mm ae=0,5D								
			1110	220	1,3	890	170	1,2	690	200	1,9
			1110	220	2,2	890	170	2,1	690	200	3,2
Stainless steels	150-240	0,2-0,8	Vc=70m/min fz=0,1mm/tooth ap=1mm ae=0,3D								
			3180	1590	14,3	2550	1280	14,4	1990	1490	21,5
			2860	1716	25,7	2290	1370	25,7	1790	1610	38,6
Cast iron	100-220	0,3-1,0	Vc=180m/min fz=0,3mm/tooth ap=1,5mm ae=0,5D								
			2860	2290	20,6	2290	1830	20,6	1790	2150	31
			2860	2860	42,9	2290	2290	42,9	1790	2690	64,6

Material	Ø40 - Ø42 (R6)			Ø50 - Ø52 (R6)			Ø40 - Ø42 (R8)			Ø50 - Ø52 (R8)		
	Rotation speed min ⁻¹	Feed rate mm/min	Q value cm ³ /min	Rotation speed min ⁻¹	Feed rate mm/min	Q value cm ³ /min	Rotation speed min ⁻¹	Feed rate mm/min	Q value cm ³ /min	Rotation speed min ⁻¹	Feed rate mm/min	Q value cm ³ /min
Mild steels (200 HB)	1990	2990	71,8	1590	3180	95,4	1990	1990	47,8	1590	2390	71,7
	Vc=250m/min fz=0,5mm/tooth ap=2mm ae=0,3D											
	1990	4780	191,2	1590	5090	254,5	1990	3180	159	1590	3820	238,8
Carbon steels Alloyed steels (30 HRC)	Vc=250m/min fz=0,8mm/tooth ap=2mm ae=0,5D											
	1590	1910	45,8	1270	2030	60,9	1590	1270	30,5	1270	1520	45,6
	1590	2860	114,4	1270	3050	152,5	1590	1910	95,5	1270	2290	143,1
Carbon steels Alloyed steels (30-40 HRC)	Vc=200m/min fz=0,6mm/tooth ap=2mm ae=0,5D											
	1190	710	17	960	770	23,1	1190	480	11,5	960	580	17,4
	1190	1070	42,8	960	1150	57,5	1190	950	47,5	960	1150	71,9
Carbon steels Alloyed steels (40-45 HRC)	Vc=150m/min fz=0,3mm/tooth ap=2mm ae=0,5D											
	800	360	6,5	640	380	8,6	800	240	4,3	640	290	6,5
	800	480	14,4	640	510	19,1	800	320	12,8	640	380	19
Carbon steels Alloyed steels (45-50 HRC)	Vc=100m/min fz=0,15mm/tooth ap=1,5mm ae=0,3D											
	640	290	3,5	510	310	4,7	640	220	4	510	260	5,9
	640	330	6,6	510	350	8,8	640	260	7,8	510	310	11,6
Alloyed steels (50-60 HRC)	Vc=80m/min fz=0,17mm/tooth ap=1mm ae=0,5D											
	550	160	1,9	440	170	2,5	550	110	1,3	440	130	1,9
	550	160	3,2	440	170	4,2	550	110	2,2	440	130	3,2
Stainless steels	Vc=70m/min fz=0,1mm/tooth ap=1mm ae=0,3D											
	1590	1430	34,3	1270	1520	45,6	1590	950	22,8	1270	1140	34,2
	1430	2150	86	1150	2300	115	1430	1720	86	1150	2070	129,4
Cast iron	Vc=180m/min fz=0,5mm/tooth ap=2mm ae=0,5D											
	1430	2150	51,6	1150	2300	69	1430	1430	34,3	1150	1730	51,9
	1430	3430	137,2	1150	3680	184	1430	2290	114,5	1150	2760	172,5

Materialien	Schnittgeschwindigkeit M/Min	Vorschubwert pro Schneide Mm/Zahn	Ø12 - Ø20			Ø24 - Ø25			Ø32 - Ø35		
			Drehungsgeschwindigkeit min ⁻¹	Vorschubwert mm/min	Q-Wert cm ³ /min	Drehungsgeschwindigkeit min ⁻¹	Vorschubwert mm/min	Q-Wert cm ³ /min	Drehungsgeschwindigkeit min ⁻¹	Vorschubwert mm/min	Q-Wert cm ³ /min
Weicher Stahl (200 HB)	150-250	0,3-0,8	3980	3180	28,6	3180	2540	28,6	2490	2990	43,1
			Vc=250m/min fz=0,4mm/Zahn ap=1,5mm ae=0,3D			Vc=250m/min fz=0,4mm/Zahn ap=1,5mm ae=0,5D					
			3980	3180	47,7	3180	2540	47,6	2490	2990	71,8
Kohlenstoffstahl Legierter Stahl (30 HRC)	120-230	0,3-0,8	3180	2540	22,9	2550	2040	23	1990	2390	34,4
			Vc=200m/min fz=0,4mm/Zahn ap=1,5mm ae=0,3D			Vc=200m/min fz=0,4mm/Zahn ap=1,5mm ae=0,5D					
			3180	2540	38,1	2550	2040	38,3	1990	2390	57,4
Kohlenstoffstahl Legierter Stahl (30-40 HRC)	100-200	0,2-0,6	2390	960	8,6	1910	760	8,6	1490	890	12,8
			Vc=150m/min fz=0,2mm/Zahn ap=1,5mm ae=0,3D			Vc=150m/min fz=0,2mm/Zahn ap=1,5mm ae=0,5D					
			2390	1430	21,5	1910	1150	21,6	1490	1340	32,2
Kohlenstoffstahl Legierter Stahl (40-45 HRC)	60-150	0,15-0,3	1590	480	2,9	1270	380	2,9	990	450	4,3
			Vc=100m/min fz=0,15mm/Zahn ap=1mm ae=0,3D			Vc=100m/min fz=0,2mm/Zahn ap=1mm ae=0,5D					
			1590	640	6,4	1270	510	6,4	990	590	9,4
Kohlenstoffstahl Legierter Stahl (45-50 HRC)	60-100	0,15-0,3	1270	380	2,3	1020	310	2,3	800	360	3,5
			Vc=80m/min fz=0,15mm/Zahn ap=1mm ae=0,3D			Vc=80m/min fz=0,15mm/Zahn ap=1mm ae=0,5D					
			1270	380	3,8	1020	310	3,9	800	360	5,8
Legierter Stahl (50-60 HRC)	50-100	0,05-0,2	1110	220	1,3	890	170	1,2	690	200	1,9
			Vc=70m/min fz=0,1mm/Zahn ap=1mm ae=0,3D			Vc=70m/min fz=0,1mm/Zahn ap=1mm ae=0,5D					
			1110	220	2,2	890	170	2,1	690	200	3,2
Rostfreier Stahl	150-240	0,2-0,8	3180	1590	14,3	2550	1280	14,4	1990	1490	21,5
			Vc=200m/min fz=0,25mm/Zahn ap=1,5mm ae=0,3D			Vc=180m/min fz=0,3mm/Zahn ap=1,5mm ae=0,5D					
			2860	1716	25,7	2290	1370	25,7	1790	1610	38,6
Guß	100-220	0,3-1,0	2860	2290	20,6	2290	1830	20,6	1790	2150	31
			Vc=180m/min fz=0,4mm/Zahn ap=1,5mm ae=0,3D			Vc=180m/min fz=0,5mm/Zahn ap=1,5mm ae=0,5D					
			2860	2860	42,9	2290	2290	42,9	1790	2690	64,6

Materialien	Ø40 - Ø42 (R6)			Ø50 - Ø52 (R6)			Ø40 - Ø42 (R8)			Ø50 - Ø52 (R8)		
	Drehungsgeschwindigkeit min ⁻¹	Vorschubwert mm/min	Q-Wert cm ³ /min	Drehungsgeschwindigkeit min ⁻¹	Vorschubwert mm/min	Q-Wert cm ³ /min	Drehungsgeschwindigkeit min ⁻¹	Vorschubwert mm/min	Q-Wert cm ³ /min	Drehungsgeschwindigkeit min ⁻¹	Vorschubwert mm/min	Q-Wert cm ³ /min
Weicher Stahl (200 HB)	1990	2990	71,8	1590	3180	95,4	1990	1990	47,8	1590	2390	71,7
	Vc=250m/min fz=0,5mm/Zahn ap=2mm ae=0,3D			Vc=250m/min fz=0,5mm/Zahn ap=2mm ae=0,3D			Vc=250m/min fz=0,5mm/Zahn ap=2mm ae=0,3D			Vc=250m/min fz=0,5mm/Zahn ap=2mm ae=0,3D		
	1990	4780	191,2	1590	5090	254,5	1990	3180	159	1590	3820	238,8
Kohlenstoffstahl Legierter Stahl (30 HRC)	1590	1910	45,8	1270	2030	60,9	1590	1270	30,5	1270	1520	45,6
	Vc=250m/min fz=0,8mm/Zahn ap=2mm ae=0,5D			Vc=200m/min fz=0,4mm/Zahn ap=2mm ae=0,3D			Vc=250m/min fz=0,8mm/Zahn ap=2,5mm ae=0,5D			Vc=200m/min fz=0,4mm/Zahn ap=2mm ae=0,3D		
	1590	2860	114,4	1270	3050	152,5	1590	1910	95,5	1270	2290	143,1
Kohlenstoffstahl Legierter Stahl (30-40 HRC)	1190	710	17	960	770	23,1	1190	480	11,5	960	580	17,4
	Vc=200m/min fz=0,6mm/Zahn ap=2mm ae=0,5D			Vc=150m/min fz=0,2mm/Zahn ap=2mm ae=0,3D			Vc=200m/min fz=0,6mm/Zahn ap=2,5mm ae=0,5D			Vc=150m/min fz=0,2mm/Zahn ap=2mm ae=0,3D		
	1190	1070	42,8	960	1150	57,5	1190	950	47,5	960	1150	71,9
Kohlenstoffstahl Legierter Stahl (40-45 HRC)	800	360	6,5	640	380	8,6	800	240	4,3	640	290	6,5
	Vc=100m/min fz=0,15mm/Zahn ap=1,5mm ae=0,3D			Vc=100m/min fz=0,15mm/Zahn ap=1,5mm ae=0,3D			Vc=100m/min fz=0,15mm/Zahn ap=1,5mm ae=0,3D			Vc=100m/min fz=0,15mm/Zahn ap=1,5mm ae=0,3D		
	800	480	14,4	640	510	19,1	800	320	12,8	640	380	19
Kohlenstoffstahl Legierter Stahl (45-50 HRC)	640	290	3,5	510	310	4,7	640	220	4	510	260	5,9
	Vc=100m/min fz=0,2mm/Zahn ap=1,5mm ae=0,5D			Vc=80m/min fz=0,17mm/Zahn ap=1,5mm ae=0,3D			Vc=100m/min fz=0,2mm/Zahn ap=2mm ae=0,5D			Vc=80m/min fz=0,17mm/Zahn ap=1,5mm ae=0,3D		
	640	330	6,6	510	350	8,8	640	260	7,8	510	310	11,6
Legierter Stahl (50-60 HRC)	550	160	1,9	440	170	2,5	550	110	1,3	440	130	1,9
	Vc=70m/min fz=0,1mm/Zahn ap=1mm ae=0,3D			Vc=70m/min fz=0,1mm/Zahn ap=1mm ae=0,3D			Vc=70m/min fz=0,1mm/Zahn ap=1mm ae=0,3D			Vc=70m/min fz=0,1mm/Zahn ap=1mm ae=0,3D		
	550	160	3,2	440	170	4,2	550	110	2,2	440	130	3,2
Rostfreier Stahl	1590	1430	34,3	1270	1520	45,6	1590	950	22,8	1270	1140	34,2
	Vc=200m/min fz=0,3mm/Zahn ap=2mm ae=0,3D			Vc=200m/min fz=0,3mm/Zahn ap=2mm ae=0,3D			Vc=200m/min fz=0,3mm/Zahn ap=2mm ae=0,3D			Vc=200m/min fz=0,3mm/Zahn ap=2mm ae=0,3D		
	1430	2150	86	1150	2300	115	1430	1720	86	1150	2070	129,4
Guß	1430	2150	51,6	1150	2300	69	1430	1430	34,3	1150	1730	51,9
	Vc=180m/min fz=0,5mm/Zahn ap=2mm ae=0,5D			Vc=180m/min fz=0,5mm/Zahn ap=2mm ae=0,5D			Vc=180m/min fz=0,5mm/Zahn ap=2mm ae=0,5D			Vc=180m/min fz=0,5mm/Zahn ap=2mm ae=0,5D		
	1430	3430	137,2	1150	3680	184	1430	2290	114,5	1150	2760	172,5



Note for above table

- In the table shown above, cutting conditions indicate regular type conditions for flank wear to be 0,3mm in 30 minutes.
- The following formula shows the chip removal volume (Q) per unit time.
 $Q(\text{cm}^3/\text{min}) = a_p(\text{mm}) \times a_e(\text{mm}) \times V_f(\text{mm}/\text{min}) / 1000$
- In the case of slotting, feed speed could be down to 70% of the whole.
- Above table shows starting points of general cutting conditions. Please adjust according to rigidity of machine tools, tooling, conditions of work-pieces and so on.
- In steel exceeding 60HRC, please set the feed value (fz) per one edge about 1/2.

Recommended cutting conditions

Material	Cutting speed Vc (m/min)	Per-flute feed rate fz (mm/tooth)	Ø63 (R6)			Ø80 (R6)			Ø100 (R6)		
			Rotation speed min ⁻¹	Feed rate mm/min	Q value cm ³ /min	Rotation speed min ⁻¹	Feed rate mm/min	Q value cm ³ /min	Rotation speed min ⁻¹	Feed rate mm/min	Q value cm ³ /min
Mild steels (200 HB)	150-250	0,3-0,8	-	3780	142,9	-	-	-	-	-	-
			Vc=250m/min fz=0,5mm/tooth ap=2mm ae=0,3D			Vc=250m/min fz=0,8mm/tooth ap=2mm ae=0,5D			Vc=250m/min fz=0,8mm/tooth ap=2mm ae=0,5D		
			1260	6050	381,2	1000	4800	384	800	3200	320
Carbon steels Alloyed steels (30 HRC)	120-230	0,3-0,8	1010	2420	91,5	-	-	-	-	-	-
			Vc=200m/min fz=0,4mm/tooth ap=2mm ae=0,3D			Vc=200m/min fz=0,6mm/tooth ap=2mm ae=0,5D			Vc=200m/min fz=0,6mm/tooth ap=2mm ae=0,5D		
			1010	3640	229,3	800	2800	230,4	640	1920	192
Carbon steels Alloyed steels (30-40 HRC)	100-200	0,2-0,6	760	910	34,4	-	-	-	-	-	-
			Vc=150m/min fz=0,2mm/tooth ap=2mm ae=0,3D			Vc=150m/min fz=0,3mm/tooth ap=2mm ae=0,5D			Vc=150m/min fz=0,3mm/tooth ap=2mm ae=0,5D		
			760	1370	86,3	600	1080	86,4	480	720	72
Carbon steels Alloyed steels (40-45 HRC)	60-150	0,15-0,3	510	460	13	-	-	-	-	-	-
			Vc=100m/min fz=0,15mm/tooth ap=1,5mm ae=0,3D			Vc=100m/min fz=0,2mm/tooth ap=1,5mm ae=0,5D			Vc=100m/min fz=0,2mm/tooth ap=1,5mm ae=0,5D		
			510	610	28,8	400	480	28,8	320	320	24
Carbon steels Alloyed steels (45-50 HRC)	60-100	0,15-0,3	400	360	6,8	-	-	-	-	-	-
			Vc=80m/min fz=0,15mm/tooth ap=1mm ae=0,3D			Vc=80m/min fz=0,17mm/tooth ap=1mm ae=0,5D			Vc=80m/min fz=0,17mm/tooth ap=1mm ae=0,5D		
			400	410	12,9	320	330	13,2	250	210	10,5
Alloyed steels (50-60 HRC)	50-100	0,05-0,2	350	210	3,9	270	160	3,8	220	110	3,3
			Vc=70m/min fz=0,1mm/tooth ap=1mm ae=0,3D			Vc=70m/min fz=0,1mm/tooth ap=1mm ae=0,5D			Vc=70m/min fz=0,1mm/tooth ap=1mm ae=0,5D		
			350	210	6,6	270	160	6,4	220	110	5,5
Stainless steels	150-240	0,2-0,8	1010	1820	68,8	-	-	-	-	-	-
			Vc=200m/min fz=0,3mm/tooth ap=2mm ae=0,3D			Vc=180m/min fz=0,5mm/tooth ap=2mm ae=0,5D			Vc=180m/min fz=0,5mm/tooth ap=2mm ae=0,5D		
			910	2730	172	720	2160	172,8	570	1430	143
Cast iron	100-220	0,3-1,0	910	2730	103,2	-	-	-	-	-	-
			Vc=180m/min fz=0,5mm/tooth ap=2mm ae=0,3D			Vc=180m/min fz=0,5mm/tooth ap=2mm ae=0,3D			Vc=180m/min fz=0,5mm/tooth ap=2mm ae=0,3D		
			910	4370	275,3	720	3640	276,8	570	2280	228
			Vc=180m/min fz=0,8mm/tooth ap=2mm ae=0,5D			Vc=180m/min fz=0,8mm/tooth ap=2mm ae=0,5D			Vc=180m/min fz=0,8mm/tooth ap=2mm ae=0,5D		

Field data

Ramping, helical milling, feeding toward Z-AXIS

There are restrictions to ramp angle (α) and cutting depth (g) toward Z-axis because of the design of the cutting edge.



ØD	Ø40	Ø50 - Ø52	Ø63 - Ø66	Ø80	Ø100	Ø125 - Ø160
Recommended α	Below 3 degrees					Below 2 degrees
h	2,5	2,5	2,5	2,5	2,5	2,5
g	3,7	3,3	5,5	5,5	5,5	5,5
Helical hole diameter	60-78	77-100	101-124	135-158	175-198	248-255

Note

- Chips may be shattered. The wearing of safety glasses and the guard are required in the vicinity of machining.

Bemerkung zur oberer Tabelle

- Auf dieser Tabelle zeigen sich die Schnittbedingungen, die regelmäßige Fräs-Bedingungen für das Flankenverschleiß um 0,3 Mm in 30 Minuten sind.
- Folgende Formel zeigt das Spanabfuhrvolumen (Q) pro Einheitszeit.

$$Q \text{ (Cm}^3\text{/Min)} = a_p \text{ (mm)} \times a_e \text{ (mm)} \times V_f \text{ (Mm/Min)} / 1000$$
- Beim Nuteneinstechen sollte die Vorschub-Geschwindigkeit bis zu 70 % des Ganzen niedriger sein.
- Diese Tabelle zeigt die Startpunkte von allgemeinen Schnittbedingungen. Diese sollen entsprechend der Stabilität der Werkzeugmaschinen, der Bearbeitung, den Bedingungen von Werkstücken usw. angepaßt werden.
- In Stahl, der härter als 60 HRC ist, setzen Sie bitte das Schneidenwert (fz) auf die Hälfte.

Empfohlene Schnittdaten

Materialien	Schnitt-Geschwindigkeit M/Min	Vorschubwert pro Schneide Mm/Zahn	Ø63 (R6)			Ø80 (R6)			Ø100 (R6)		
			Drehung-Geschwindigkeit min ⁻¹	Vorschubwert mm/min	Q-Wert cm ³ /min	Drehung-Geschwindigkeit min ⁻¹	Vorschubwert mm/min	Q-Wert cm ³ /min	Drehung-Geschwindigkeit min ⁻¹	Vorschubwert mm/min	Q-Wert cm ³ /min
Weicher Stahl (200 HB)	150-250	0,3-0,8	-	3780	142,9	-	-	-	-	-	-
			Vc=250m/min fz=0,5mm/Zahn ap=2mm ae=0,3D			Vc=250m/min fz=0,8mm/Zahn ap=2mm ae=0,5D			Vc=250m/min fz=0,8mm/Zahn ap=2mm ae=0,5D		
			1260	6050	381,2	1000	4800	384	800	3200	320
Kohlenstoffstahl Legierter Stahl (30 HRC)	120-230	0,3-0,8	1010	2420	91,5	-	-	-	-	-	-
			Vc=200m/min fz=0,4mm/Zahn ap=2mm ae=0,3D			Vc=200m/min fz=0,6mm/Zahn ap=2mm ae=0,5D			Vc=200m/min fz=0,6mm/Zahn ap=2mm ae=0,5D		
			1010	3640	229,3	800	2800	230,4	640	1920	192
Kohlenstoffstahl Legierter Stahl (30-40 HRC)	100-200	0,2-0,6	760	910	34,4	-	-	-	-	-	-
			Vc=150m/min fz=0,2mm/Zahn ap=2mm ae=0,3D			Vc=150m/min fz=0,3mm/Zahn ap=2mm ae=0,5D			Vc=150m/min fz=0,3mm/Zahn ap=2mm ae=0,5D		
			760	1370	86,3	600	1080	86,4	480	720	72
Kohlenstoffstahl Legierter Stahl (40-45 HRC)	60-150	0,15-0,3	510	460	13	-	-	-	-	-	-
			Vc=100m/min fz=0,15mm/Zahn ap=1,5mm ae=0,3D			Vc=100m/min fz=0,2mm/Zahn ap=1,5mm ae=0,5D			Vc=100m/min fz=0,2mm/Zahn ap=1,5mm ae=0,5D		
			510	610	28,8	400	480	28,8	320	320	24
Kohlenstoffstahl Legierter Stahl (45-50 HRC)	60-100	0,15-0,3	400	360	6,8	-	-	-	-	-	-
			Vc=80m/min fz=0,15mm/Zahn ap=1mm ae=0,3D			Vc=80m/min fz=0,17mm/Zahn ap=1mm ae=0,5D			Vc=80m/min fz=0,17mm/Zahn ap=1mm ae=0,5D		
			400	410	12,9	320	330	13,2	250	210	10,5
Legierter Stahl (50-60 HRC)	50-100	0,05-0,2	350	210	3,9	270	160	3,8	220	110	3,3
			Vc=70m/min fz=0,1mm/Zahn ap=1mm ae=0,3D			Vc=70m/min fz=0,1mm/Zahn ap=1mm ae=0,5D			Vc=70m/min fz=0,1mm/Zahn ap=1mm ae=0,5D		
			350	210	6,6	270	160	6,4	220	110	5,5
Rostreier Stahl	150-240	0,2-0,8	1010	1820	68,8	-	-	-	-	-	-
			Vc=200m/min fz=0,3mm/Zahn ap=2mm ae=0,3D			Vc=180m/min fz=0,5mm/Zahn ap=2mm ae=0,5D			Vc=180m/min fz=0,5mm/Zahn ap=2mm ae=0,5D		
			910	2730	172	720	2160	172,8	570	1430	143
Guß	100-220	0,3-1,0	910	2730	103,2	-	-	-	-	-	-
			Vc=180m/min fz=0,5mm/Zahn ap=2mm ae=0,3D			Vc=180m/min fz=0,8mm/Zahn ap=2mm ae=0,5D			Vc=180m/min fz=0,8mm/Zahn ap=2mm ae=0,5D		
			910	4370	275,3	720	3640	276,8	570	2280	228

Beispiel

Einwärtskopieren, Zirkularfräsen, Vorschub zur Z-Achse

Es gibt Beschränkungen zum Rampen-Winkel (α) und Schnitttiefe (g) zur Z-Achse wegen des Designs der Schneide.

Einwärtskopieren

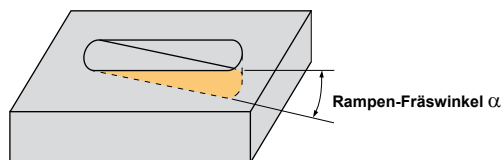

Zirkularfräsen

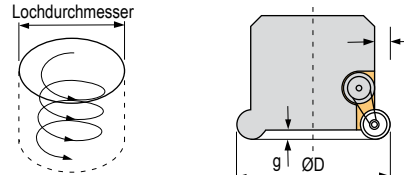

ØD	Ø40	Ø50 - Ø52	Ø63 - Ø66	Ø80	Ø100	Ø125 - Ø160
Empfohlenes α	Unter 3 Grad					Unter 2 Grad
h	2,5	2,5	2,5	2,5	2,5	2,5
g	3,7	3,3	5,5	5,5	5,5	5,5
Spiral-Lochdurchmesser	60-78	77-100	101-124	135-158	175-198	248-255

Bemerkung

- Späne können zerschmettert werden. Das Tragen der Sicherheitsbrille und die Sicherheitsabdeckung sind erforderlich in der Nähe des Bearbeitungsplatzes.



Characteristics:

General application end mill for slot milling, peripheral milling, ramp milling and drilling, pocket milling and copy milling.

Recommended for the machining of aluminium, plastics and exotic materials.

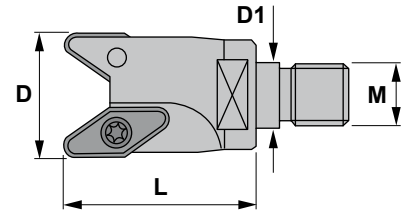

Eigenschaften:

Einschraubfräser für allgemeine Anwendungen wie Nutenfräsen, Konturfräsen, Stufenfräsen, Bohren, Taschenfräsen und Kopieren.

Für die Bearbeitung von Aluminium, Kunststoff und exotische Materialien empfohlen.

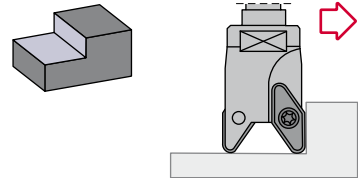

0344.06

Reference Bezeichnung		D	L	M	D1	Insert size Wendschneidplatte	
0344.06.015	2	15	35	M8	8,5	VCGT 1103..	0,040
0344.06.020	2	20	35	M10	10,5	VCGT 1103..	0,070
0344.06.025	2	25	50	M12	12,5	VCGT 1604..	0,110
0344.06.032	2	32	50	M16	17,0	VCGT 2205..	0,240
0344.06.042	3	42	50	M16	17,0	VCGT 2205..	0,400

Reference Bezeichnung			Nm
0344.06.015	1225	5507	0.9
0344.06.020	1225	5507	0.9
0344.06.025	1341	5515	3.0
0344.06.032	1250	5520	4.0
0344.06.042	1250	5520	4.0

VCGT

35° rhombic positive inserts with 7° clearance. F22
35° rhombische positive Wendschneidplatten mit 7° Freiwinkel.

Reference / Bez.	l	s	d
VCGT 1103..	11,00	3,18	6,35
VCGT 1604..	16,50	4,76	9,52
VCGT 2205..	22,10	5,56	12,70

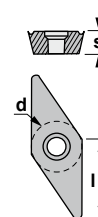

VCGT-AL



VCGT-AP





Characteristics:

General application bottom cutter for slot milling, peripheral milling, ramp milling and drilling, pocket milling and copy milling.

Recommended for the machining of aluminium, plastics and exotic materials.

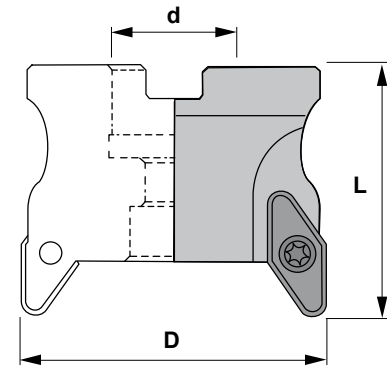

Eigenschaften:

Messerkopf für allgemeine Anwendungen wie Nutenfräsen, Konturfräsen, Stufenfräsen, Bohren, Taschenfräsen und Kopieren.

Für die Bearbeitung von Aluminium, Kunststoff und exotische Materialien empfohlen.

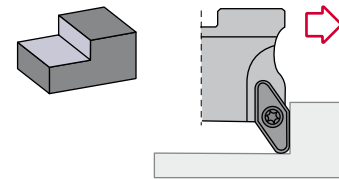

0344.90

Reference Bezeichnung		D	d	L	Insert size Wendeschneidplatte	
0344.90.042	3	42	16	55	VCGT 2205..	0,180
0344.90.052	3	52	22	55	VCGT 2205..	0,350
0344.90.066	4	66	27	55	VCGT 2205..	0,800
0344.90.080	5	80	27	55	VCGT 2205..	1,150

Reference Bezeichnung			Nm
0344.90.042	1250	5520	4.0
0344.90.052	1250	5520	4.0
0344.90.066	1250	5520	4.0
0344.90.080	1250	5520	4.0

VCGT

35° rhombic positive inserts with 7° clearance. F22
35° rhombische positive Wendeschneidplatten mit 7° Freiwinkel.

Reference / Bez.	l	s	d
VCGT 2205..	22,10	5,56	12,70

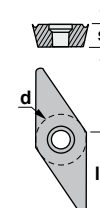

VCGT-AL



VCGT-AP



Recommended cutting conditions
Empfohlene Schnittdaten

Material / Materialien		Cutting speed / Schnittgeschwindigkeit	
		ZR 10 Vc (mm/min)	KM 15 Vc (mm/min)
Aluminium alloys / Aluminium-Legierungen	Rm < 280 N/mm ²	1500	1000
	Rm < 280 N/mm ²	1000	800
Copper alloys / Kupfer-Legierungen	Long chipping / Langspanend	300	250
Thermoplastics / Thermoplaste			300
Aluminium alloys / Aluminium-Legierungen	Si < 12 %	100	800
	Si < 12 %	200	
Copper alloys / Kupfer-Legierungen	Short chipping / Kurzspanend	500	400
Magnesium alloys / Magnesium-Legierungen			400
Duroplastics / Duroplaste		200	150

Maximum feed per tooth / Maximales Vorschub pro Zahn fz (mm/z) in mm

VCGT 1103..	VCGT 1604..	VCGT 2205..
0,25	0,35	0,5
0,2	0,3	0,4

Recommendations for further applications
Weitere Anwendungsempfehlungen

Pocket milling and axial plunging
Taschenfräsen und axiales Eintauchen

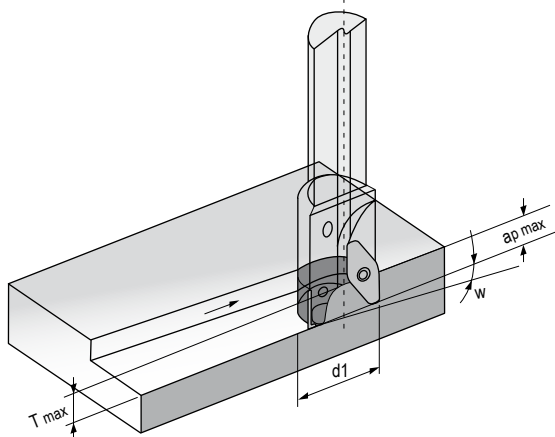

Circular milling
Zirkularfräsen

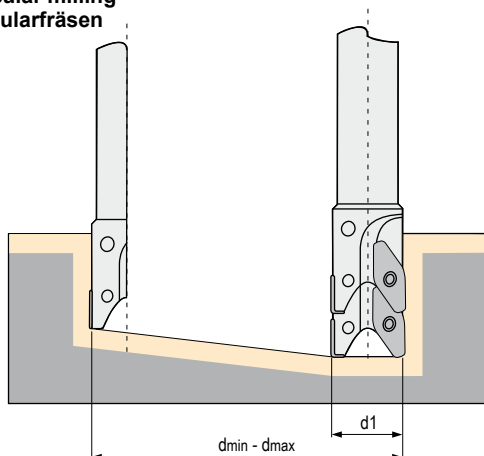

Helix angle W1 max and internal depth of cut Tmax
Helixwinkel W1 max und innere Schnitttiefe Tmax

	VCGT 110304-ALM	VCGT 160412-ALM	VCGT 220530-ALM
ap max	10	13,5	15
T max	6	8	9
W1 max degree / Grad			
15			
20	25		
25		24	
32			22
42			15
52			12
66			9
80			7

d1 mm	dmin mm	dmax mm
15	15	15
20	20	20
25	25	25
32	32	32
42	42	42
52	52	52
66	66	66
80	80	80



Characteristics:

Indexable ball nose semi-finishing and finishing cutter equipped with a positive insert that provides low cutting forces and reduced vibration.

It works well on steels, hardened steels, stainless steels and casts.

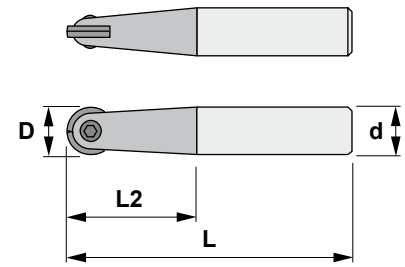

Eigenschaften:

Kugelbahnfräser zum Halb-Schlichten und Schlichten mit positiven Wendeschneidplatten, die niedrige Schnittkräfte und reduzierte Vibrationen bieten.

Für Stahl, gehärteten Stahl, rostfreien Stahl und Guß empfohlen.

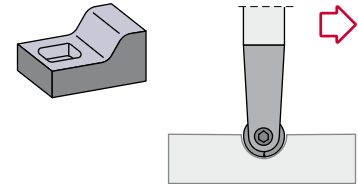

85_0

Reference Bezeichnung		D	L	L2	d	Insert size Wendeschneidplatte	
8530.00.010	2	10	105	35	12	HPR 10	0,100
8540.00.012	2	12	105	35	16	HPR 12	0,240
8550.00.016	2	16	105	45	20	HPR 16	0,260
8560.00.020	2	20	125	50	25	HPR 20	0,500
8580.00.025	2	25	125	55	32	HPR 25	0,750
8590.00.032	2	32	125	55	32	HPR 32	0,800
8530.01.010	2	10	150	50	12	HPR 10	0,200
8540.01.012	2	12	160	50	16	HPR 12	0,300
8550.01.016	2	16	180	70	20	HPR 16	0,400
8560.01.020	2	20	200	70	25	HPR 20	0,700
8580.01.025	2	25	220	100	32	HPR 25	1,250
8590.01.032	2	32	250	100	32	HPR 32	1,550

Reference Bezeichnung				Nm
8530.00.010				3.0
8540.00.012				4.0
8550.00.016				4.0
8560.00.020				4.0
8580.00.025			5530	7.0
8590.00.032			5530	7.0
8530.01.010				3.0
8540.01.012				4.0
8550.01.016				4.0
8560.01.020				4.0
8580.01.025			5530	7.0
8590.01.032			5530	7.0

HPR

Round positive insert with 11° clearance. F14
Runde positive Wendeschneidplatte mit 11° Freiwinkel.

Reference / Bezeichnung	s	d
HPR 10	2,50	10,00
HPR 12	2,50	12,00
HPR 16	3,00	16,00
HPR 20	3,00	20,00
HPR 25	4,00	25,00
HPR 32	5,00	32,00

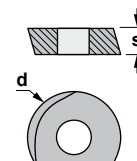



Characteristics:

Indexable ball nose semi-finishing and finishing cutter equipped with a positive insert that provides low cutting forces and reduced vibration.

It works well on steels, hardened steels, stainless steels and casts.

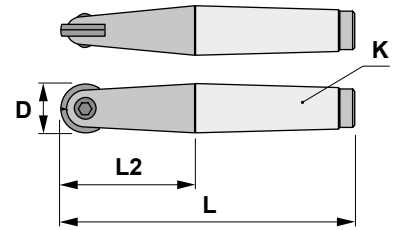

Eigenschaften:

Kugelbahnfräser zum Halb-Schlichten und Schlichten mit positiven Wendeschneidplatten, die niedrige Schnittkräfte und reduzierte Vibrationen bieten.

Für Stahl, gehärteten Stahl, rostfreien Stahl und Guß empfohlen.

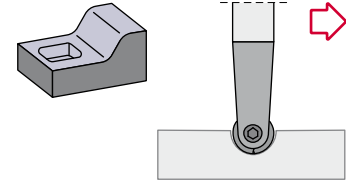

85_3

Reference Bezeichnung		D	L	K	L2	Insert size Wendeschneidplatte	
8580.34.025	2	25	215	4	135	HPR 25	1,150
8590.34.032	2	32	268	4	160	HPR 32	1,550



Reference Bezeichnung				Nm
8580.34.025	1609	-	5530	7.0
8590.34.032	1809	5515	-	3.0

HPR

Round positive insert with 11° clearance. F14
Runde positive Wendeschneidplatte mit 11° Freiwinkel.

Reference / Bez.	s	d
HPR 25	4,00	25,00
HPR 32	5,00	32,00

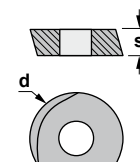



Characteristics:

Indexable ball nose semi-finishing and finishing cutter equipped with a positive insert that provides low cutting forces and reduced vibration.

It works well on steels, hardened steels, stainless steels and casts.

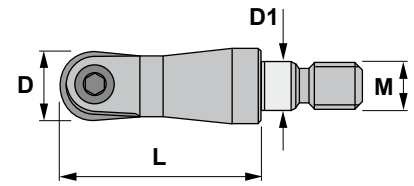

Eigenschaften:

Kugelbahnfräser zum Halb-Schlichten und Schlichten mit positiven Wendeschneidplatten, die niedrige Schnittkräfte und reduzierte Vibrationen bieten.

Für Stahl, gehärteten Stahl, rostfreien Stahl und Guß empfohlen.

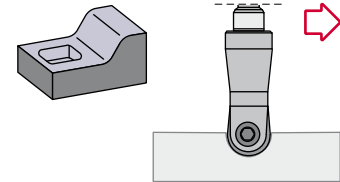

85_06

Reference Bezeichnung		D	L	M	D1	Insert size Wendeschneidplatte	
8530.06.010	2	10	23	M6	6,5	HPR 10	0,016
8540.06.012	2	12	23	M6	6,5	HPR 12	0,030
8550.06.016	2	16	30	M8	8,5	HPR 16	0,050
8560.06.020	2	20	35	M10	10,5	HPR 20	0,095
8580.06.025	2	25	40	M12	12,5	HPR 25	0,160

Reference Bezeichnung				Nm
8530.06.010	1359	5515	-	3.0
8540.06.012	1509	5520	-	4.0
8550.06.016	1519	5520	-	4.0
8560.06.020	1529	5520	-	4.0
8580.06.025	1609	-	5530	7.0

HPR

Round positive insert with 11° clearance. F14
Runde positive Wendeschneidplatte mit 11° Freiwinkel.

Reference / Bezeichnung

s

d

HPR 10	2,40	10,00
HPR 12	2,50	12,00
HPR 16	3,00	16,00
HPR 20	3,00	20,00
HPR 25	4,00	25,00

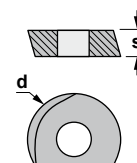

HPR





Characteristics:

Indexable ball nose mirror finishing cutter equipped with a positive insert that provides low cutting forces and reduced vibration. It works well on steels, hardened steels, stainless steels and casts.

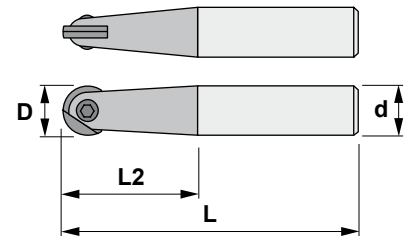

Eigenschaften:

Kugelbahnfräser zum Schlichten mit positiven Wendeschneidplatten, die niedrige Schnittkräfte und reduzierte Vibrationen bieten.

Für Stahl, gehärteten Stahl, rostfreien Stahl und Guß empfohlen.

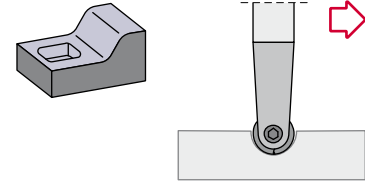

88_0

Reference Bezeichnung		D	L	d	L2	Insert size Wendeschneidplatte	
8830.00.010	2	10	105	10	50	RPR 10	0,100
8840.00.012	2	12	105	12	50	RPR 12	0,240
8850.00.016	2	16	105	16	50	RPR 16	0,260
8860.00.020	2	20	125	20	70	RPR 20	0,500
8880.00.025	2	25	125	25	70	RPR 25	0,750
8890.00.032	2	32	125	32	70	RPR 32	0,800
8830.01.010	2	10	150	10	80	RPR 10	0,200
8840.01.012	2	12	160	12	90	RPR 12	0,300
8850.01.016	2	16	180	16	100	RPR 16	0,400
8860.01.020	2	20	200	20	120	RPR 20	0,700
8880.01.025	2	25	220	25	140	RPR 25	1,250
8890.01.032	2	32	250	32	160	RPR 32	1,550

Reference Bezeichnung				Nm
8830.00.010	1353	5508	-	1.2
8840.00.012	1354	5510	-	2.0
8850.00.016	1619	5515	-	3.0
8860.00.020	1529	5520	-	4.0
8880.00.025	1609	-	5530	7.0
8890.00.032	1809	-	5530	7.0
8830.01.010	1353	5508	-	1.2
8840.01.012	1354	5510	-	2.0
8850.01.016	1619	5515	-	3.0
8860.01.020	1529	5520	-	4.0
8880.01.025	1609	-	5530	7.0
8890.01.032	1809	-	5530	7.0

RPR

Round positive insert with 11° clearance. F14
Runde positive Wendeschneidplatte mit 11° Freiwinkel.

Reference / Bezeichnung	s	d
RPR 10	2,60	10,00
RPR 12	3,00	12,00
RPR 16	4,00	16,00
RPR 20	5,00	20,00
RPR 25	6,00	25,00
RPR 32	7,00	32,00

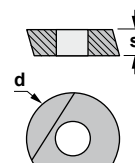



Characteristics:

Indexable ball nose mirror finishing cutter equipped with a positive insert that provides low cutting forces and reduced vibration. It works well on steels, hardened steels, stainless steels and casts.

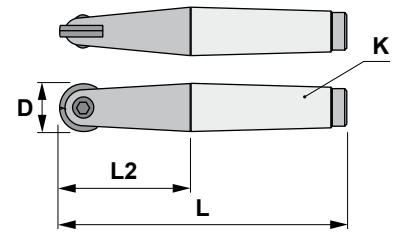

Eigenschaften:

Kugelbahnfräser zum Schlichten mit positiven Wendeschneidplatten, die niedrige Schnittkräfte und reduzierte Vibrationen bieten.

Für Stahl, gehärteten Stahl, rostfreien Stahl und Guß empfohlen.

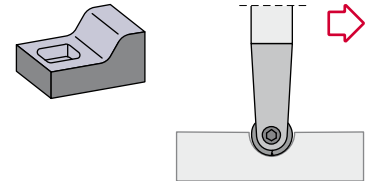

88_3

Reference Bezeichnung		D	L	K	L2	Insert size Wendeschneidplatte	
8860.30.020	2	20	190	3	115	RPR 20	0,670
8880.34.025	2	25	215	4	135	RPR 25	1,200
8890.34.032	2	32	268	4	160	RPR 32	1,650

Reference Bezeichnung				Nm
8860.30.020	1529	5520	-	4.0
8880.34.025	1609	-	5530	7.0
8890.34.032	1809	-	5530	7.0

RPR

Round positive insert with 11° clearance. F16
Runde positive Wendeschneidplatte mit 11° Freiwinkel.

Reference / Bezeichnung	s	d
RPR 20	5,00	20,00
RPR 25	6,00	25,00
RPR 32	7,00	32,00

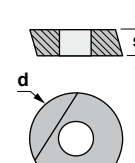

RPR





Characteristics:

Indexable ball nose mirror finishing cutter equipped with a positive insert that provides low cutting forces and reduced vibration. It works well on steels, hardened steels, stainless steels and casts.

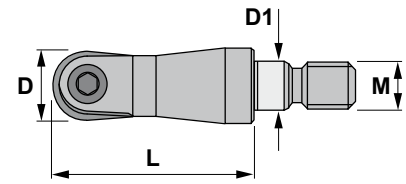

Eigenschaften:

Kugelbahnfräser zum Schlichten mit positiven Wendeschneidplatten, die niedrige Schnittkräfte und reduzierte Vibrationen bieten.

Für Stahl, gehärteten Stahl, rostfreien Stahl und Guß empfohlen.

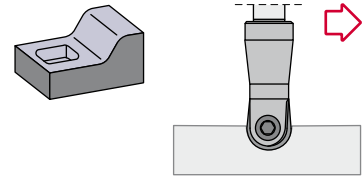

88_06

Reference Bezeichnung		D	L	K	D1	Insert size Wendeschneidplatte	
8830.06.010	2	10	23	M6	6,5	RPR 10	0,016
8840.06.012	2	12	23	M6	6,5	RPR 12	0,030
8850.06.016	2	16	30	M8	8,5	RPR 16	0,050
8860.06.020	2	20	30	M10	10,5	RPR 20	0,095
8880.06.025	2	25	35	M12	12,5	RPR 25	0,160

Reference Bezeichnung				Nm
8830.06.010	1353	5508	-	1.2
8840.06.012	1354	5510	-	2.0
8850.06.016	1619	5515	-	3.0
8860.06.020	1529	5520	-	4.0
8880.06.025	1609	-	5530	7.0

RPR

Round positive insert with 11° clearance. F16
Runde positive Wendeschneidplatte mit 11° Freiwinkel.

Reference / Bezeichnung	s	d
RPR 10	2,60	10,00
RPR 12	3,00	12,00
RPR 16	4,00	16,00
RPR 20	5,00	20,00
RPR 25	6,00	25,00

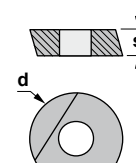

RPR



Recommended cutting conditions

Material	m/min Cutting speed	mm/tooth Feed rate	Ø8		Ø10		Ø12			
			min ⁻¹	mm/min	min ⁻¹	mm/min	min ⁻¹	mm/min		
Carbon steels Alloyed steels (30 HRC)	100-200	0,2-0,3	6370	2550	5090	2040	4240	1700		
Vc=160m/min fz=0,2mm/tooth ap=0,025D ae=0,1D										
Carbon steels Alloyed steels (30-40 HRC)	80-150	0,2-0,3	4770	1910	3820	1530	3180	1270		
Vc=120m/min fz=0,2mm/tooth ap=0,025D ae=0,1D										
Die tool steels Pre-hardened steels (30-40 HRC)	70-100	0,1-0,15	3180	640	2550	510	2120	420		
Vc=80m/min fz=0,1mm/tooth ap=0,025D ae=0,1D										
Hardened steels (55-65 HRC)	200-250	0,2-0,4	9150	3660	7320	2930	6100	2440		
Vc=230m/min fz=0,2mm/tooth ap=0,01D ae=0,02D										
Cast iron	100-200	0,3-0,4	6730	3820	5090	3050	4240	2550		
Vc=160m/min fz=0,3mm/tooth ap=0,025D ae=0,1D										

Material	m/min Cutting speed	mm/tooth Feed rate	Ø16		Ø20		Ø25		Ø30(32)	
			min ⁻¹	mm/min	min ⁻¹	mm/min	min ⁻¹	mm/min	min ⁻¹	mm/min
Carbon steels Alloyed steels (30 HRC)	100-200	0,2-0,3	2400	1600	2550	1300	2050	1030	1700	850
Vc=160m/min fz=0,25mm/tooth ap=0,05D ae=0,1D										
Carbon steels Alloyed steels (30-40 HRC)	80-150	0,2-0,3	1600	1200	1910	955	1530	765	1280	640
Vc=120m/min fz=0,25mm/tooth ap=0,05D ae=0,1D										
Die tool steels Pre-hardened steels (30-40 HRC)	70-100	0,1-0,15	3200	385	1280	310	1020	245	850	205
Vc=80m/min fz=0,12mm/tooth ap=0,05D ae=0,1D										
Hardened steels (55-65 HRC)	200-250	0,2-0,4	4575	2740	3660	2200	2930	1760	2440	1460
Vc=230m/min fz=0,3mm/tooth ap=0,01D ae=0,02D										
Cast iron	100-200	0,3-0,4	3200	2240	2550	1790	2050	1440	1700	1190
Vc=160m/min fz=0,35mm/tooth ap=0,05D ae=0,1D										

Note

- According to the machining situation, refer to the table above to determine the cutting conditions.
 - Be sure to practice safety instructions and precautions such as wearing glasses and safety shoes, and placing safety covers when you use this tool.
- This tool can be broken during machining, so failure to follow these instructions may cause personal injury.

$$n = \frac{V_c \cdot 1000}{\pi \cdot \text{Def.}} \quad (\text{Rev./min.})$$

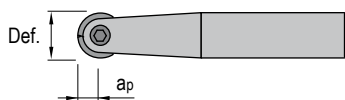

N = Spindle speed (Rev./min.)
 Vc = Cutting speed
 Def. = Effective cutting diameter
 ap = Max. Depth of cut (mm)

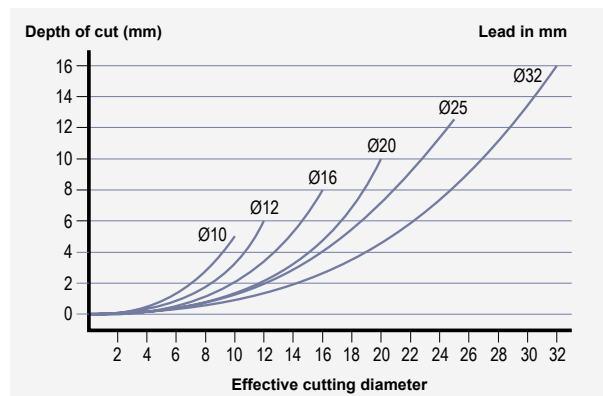

Empfohlene Schnittdaten

Materialien	mm/min Schnittgeschwindigkeit	mm/Zahn Vorschubwert	Ø8		Ø10		Ø12			
			min ⁻¹	mm/min	min ⁻¹	mm/min	min ⁻¹	mm/min		
Kohlenstoffstahl Legierter Stahl	100-200	0,2-0,3	6370	2550	5090	2040	4240	1700		
			Vc=160m/min fz=0,2mm/Zahn ap=0,025D ae=0,1D							
Kohlenstoffstahl Legierter Stahl	80-150	0,2-0,3	4770	1910	3820	1530	3180	1270		
			Vc=120m/min fz=0,2mm/Zahn ap=0,025D ae=0,1D							
Formenbaustahl Vorgehärteter Stahl	70-100	0,1-0,15	3180	640	2550	510	2120	420		
			Vc=80m/min fz=0,1mm/Zahn ap=0,025D ae=0,1D							
Gehärteter Stahl	200-250	0,2-0,4	9150	3660	7320	2930	6100	2440		
			Vc=230m/min fz=0,2mm/Zahn ap=0,01D ae=0,02D							
Guß	100-200	0,3-0,4	6730	3820	5090	3050	4240	2550		
			Vc=160m/min fz=0,3mm/Zahn ap=0,025D ae=0,1D							

Materialien	mm/min Schnittgeschwindigkeit	mm/Zahn Vorschubwert	Ø16		Ø20		Ø25		Ø30(32)	
			min ⁻¹	mm/min	min ⁻¹	mm/min	min ⁻¹	mm/min	min ⁻¹	mm/min
Kohlenstoffstahl Legierter Stahl	100-200	0,2-0,3	2400	1600	2550	1300	2050	1030	1700	850
			Vc=160m/min fz=0,25mm/Zahn ap=0,05D ae=0,1D							
Kohlenstoffstahl Legierter Stahl	80-150	0,2-0,3	1600	1200	1910	955	1530	765	1280	640
			Vc=120m/min fz=0,25mm/Zahn ap=0,05D ae=0,1D							
Formenbaustahl Vorgehärteter Stahl	70-100	0,1-0,15	3200	385	1280	310	1020	245	850	205
			Vc=80m/min fz=0,12mm/Zahn ap=0,05D ae=0,1D							
Gehärteter Stahl	200-250	0,2-0,4	4575	2740	3660	2200	2930	1760	2440	1460
			Vc=230m/min fz=0,3mm/Zahn ap=0,01D ae=0,02D							
Guß	100-200	0,3-0,4	3200	2240	2550	1790	2050	1440	1700	1190
			Vc=160m/min fz=0,35mm/Zahn ap=0,05D ae=0,1D							

Bemerkung

- Gemäß der Bearbeitungssituation, beziehen Sie sich auf der Tabelle oben, um die Schnittbedingungen zu bestimmen.
- Sorgen Sie dafür, dass Sicherheitsinstruktionen und Vorsichtsmaßnahmen (wie das Tragen der Brille und Sicherheitsschuhe) eingehalten werden und verwenden Sie Sicherheitsabdeckungen, immer wenn Sie dieses Werkzeug einsetzen.
- Da dieses Werkzeug während der Bearbeitung brechen kann, könnte das nicht Beachten von diesen Instruktionen persönliche Verletzungen verursachen.

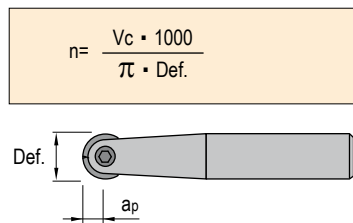

N = Spindel-Geschwindigkeit (Umdrehungen/Minute)
 Vc = Schnittgeschwindigkeit
 Def. = Wirksamer Schnittdurchmesser
 ap = Maximale Schnitttiefe (mm)

